



2024-25 v2
INNOVATIONS GUIDE



GLOBAL ORDERING INFORMATION

CUSTOMER CARE

Toll-free within the U.S. and Canada: **800.842.8688**
Direct Dial: **+1 712.737.8688**
Facsimile: **877.613.6300**
Direct Sales Email: **CQorder@CQmedical.com**
Distributor Sales Email: **distorder@CQmedical.com**
OEM Email: **oemorder@CQmedical.com**

OFFICE HOURS

Monday – Thursday, 7:30 a.m. – 6:00 p.m.,
Friday 7:30 a.m. – 5:00 p.m. U.S. Eastern Time.

SHIPPING

Shipping is the responsibility of the customer. Refer to the Standard Terms and Conditions* for more information.

PRICING

Prices are subject to change without notice.
Minimum purchase quantities or amounts may apply.
Please contact Customer Care for details.

SAMPLE REQUESTS

Free non-sterile samples are available on selected products. Samples are provided for sizing and fit purposes only and should not be used in clinical procedures.

RETURN POLICY

If the merchandise you received is defective or not as you ordered, please contact Customer Care within 30 days of invoice date for assistance. Returned products may be subject to additional restocking fees. Please refer to the Standard Terms and Conditions* for more information.

CLAIMS, SHORTAGES OR DAMAGES

Open all shipments immediately and inspect for concealed damages, shortages or errors. If goods were damaged in shipping, please hold the package and request a carrier inspection and claim form. Please report any shortages or errors to Customer Care within 30 days of receipt of shipment.

PRODUCT WARRANTY

Product warranty information is available on CQmedical.com

QUALITY STANDARDS

CQ Medical complies with ISO 13485:2016 Quality Standards. Note: Not all products listed are available in every market. Please contact your account representative or local distributor for availability.

*Terms and conditions subject to change without notice. Contact Customer Care for most updated terms and conditions.

A NEW NAME, A NEW GLOBAL LEADER



CQ Medical is the **new global leader** in patient radiotherapy positioning and healthcare innovations that advance human care. From researchers and scientists to designers and developers, CQ Medical is at the forefront of cutting-edge, patient-centric medical technology designed to deliver the **best possible outcomes**.

CQ Medical was born by bringing together the innovations of our two legacy companies, CIVCO Radiotherapy and Qfix. Under one roof, we have a combined **80 years of experience**, making significant impact on medical treatment and care, and a profound difference in patients' lives.

This is an exciting time for us. And for you. We look forward to providing you with all the **innovations that make you and your patients better**. We invite you to peruse the following pages for the products you've come to trust, and look forward to what's on the horizon.

If you have any questions, please email us at **info@CQmedical.com**.

Care Smarter
CQ Medical



6-25

COUCHTOPS
& OVERLAYS

28-34

SYMPHONY® IMAGING,
TREATMENT &
TRANSFER SOLUTION

35-39

BRACHYTHERAPY

40-45

ALL IN ONE
SOLUTIONS

146-158

HIP, PELVIS &
EXTREMITIES

159-172

VACUUM &
POSITIONING
CUSHIONS

174-181

FIDUCIAL MARKERS

182-189

PATIENT MARKING

47-64

SBRT
(STEREOTACTIC
BODY RADIATION
THERAPY)

68-77

SRS/SRT
(STEREOTACTIC
RADIOSURGERY/
RADIOTHERAPY)

80-123

HEAD & NECK AND
THERMOPLASTICS

126-145

BREAST & THORAX

190-198

MRSERIES™

199-216

PROTONSERIES®

217-226

ACCESSORIES,
AIDS & STORAGE



IQ + EQ = CQ

We care with our hearts.
With our actions.
It comes from the deep well of empathy
that lives inside us all.
But we also care with our minds.
With our designs and our discipline.
It's in the intelligence with which we
approach what we do.
Making treatment more precise,
Technologies more effective,
The genius minds of medicine more brilliant.
Advancing the cause of health forward.
This combination of intelligence and emotion
can be found in every one of our designs,
in all our people, and everything we do.
It is this coming together of IQ and EQ
that makes us unique.
That makes us CQ Medical.
To us, care is more than an emotion,
It is a decision.
Which is what makes us the global leader
in patient radiotherapy positioning and
healthcare innovation.
Because we care smarter than anyone.
And make care smarter for everyone.

 **CQ MEDICAL™**
Care Smarter

Couchtops & Overlays

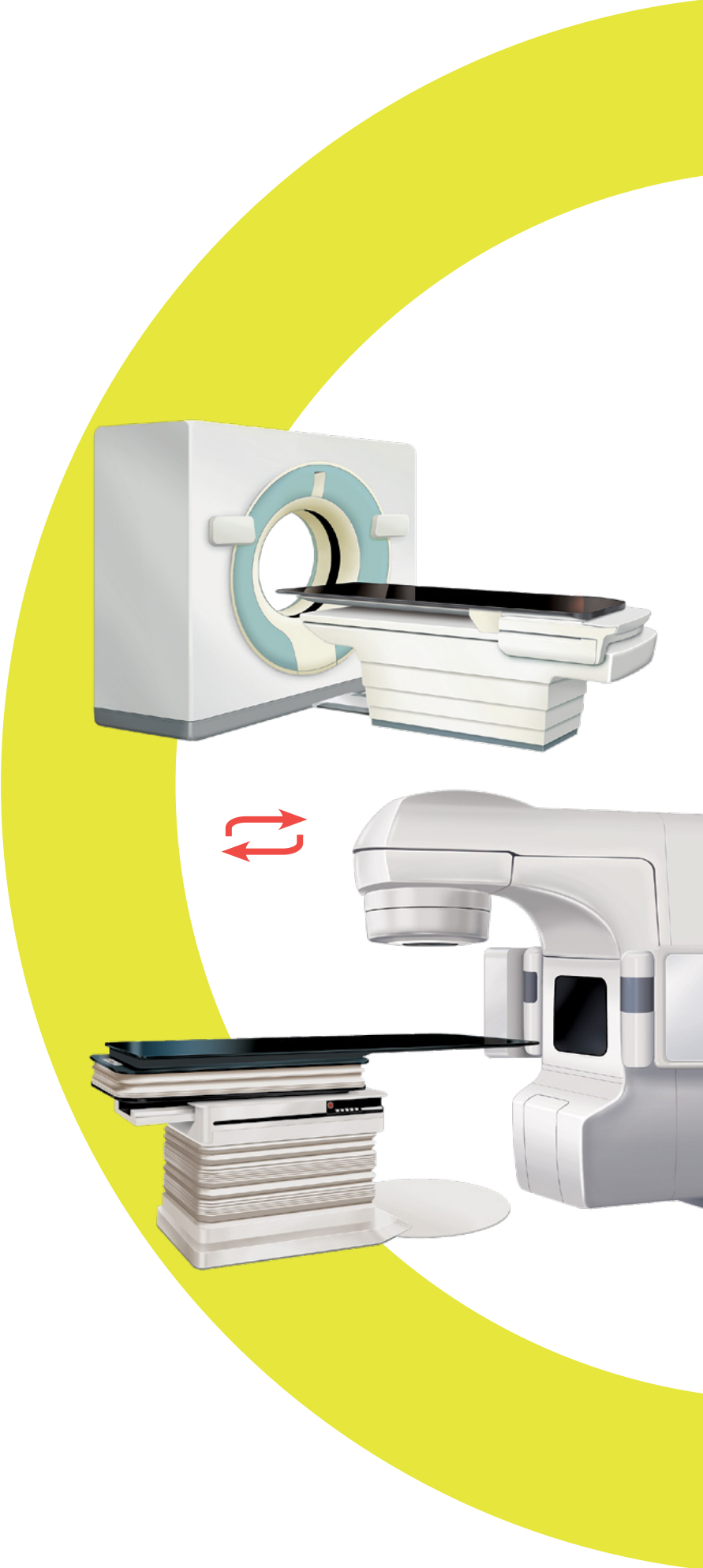

COUCHTOPS & OVERLAYS



9-13

UNIVERSAL COUCHTOP
LONG EXTENSION AND
1 PIECE

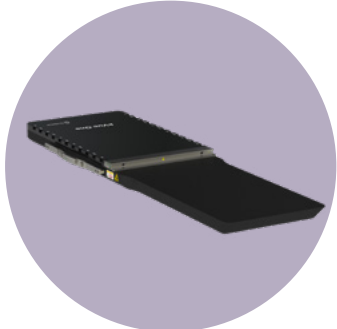

14-19

KVUE COUCHTOPS



20-21

CT OVERLAYS



22-24

LOK-BARS AND
LOCATING BARS



25

COUCHTOP PADS

CQ MEDICAL EDUCATION CENTER

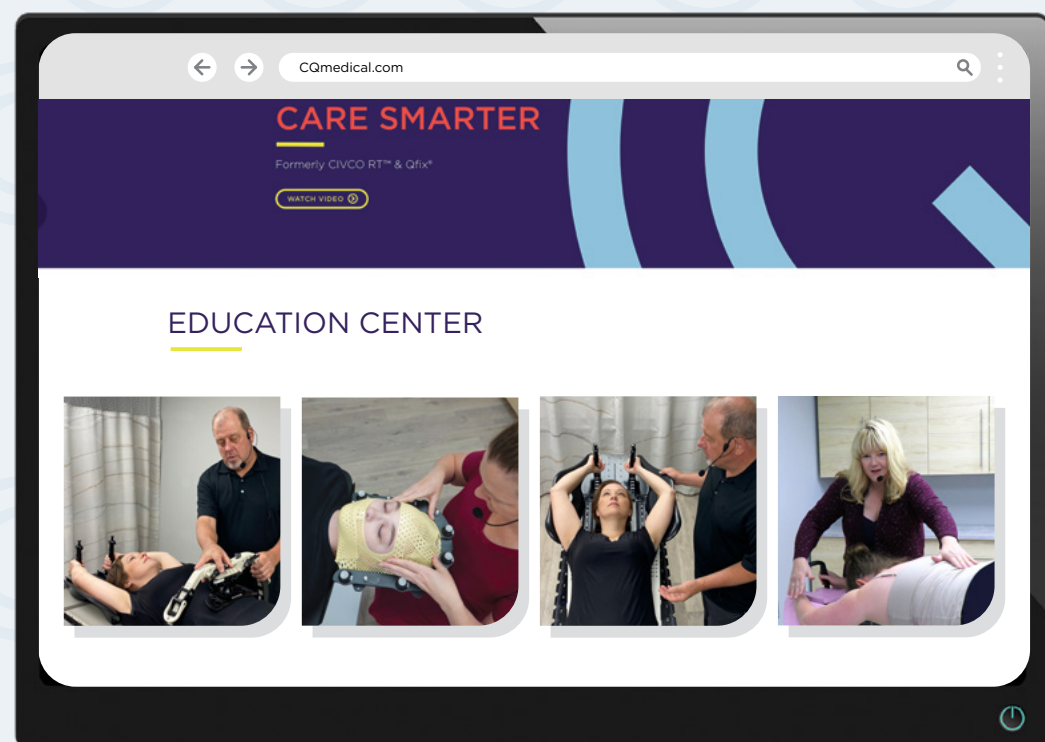

The CQ Medical Education Center is designed to **simulate a clinical environment** and **facilitate educational webinars**. The center allows us to provide **uninterrupted support** to our clinical partners around the world.

One of the greatest benefits of an interactive, web-based session is the ability to showcase our positioning & immobilization solutions and treatment options. It helps us understand your current workflow so that we can **focus on the device and techniques that work best for you**.

We are excited to offer a live learning resource to our customers & partners!



**VIEW OUR CE WEBINAR OPPORTUNITIES OR
SCHEDULE A TRAINING COURSE**

Universal Couchtop™ Long Extension

JUNCTION, RAIL AND ARTIFACT-FREE

The Universal Couchtop is a modern and comprehensive solution for enabling advanced treatments in your clinic. Specifically designed to answer the demands of IGRT delivery, the Universal Couchtop Long Extension contains no rails or junctions in the treatment area to help facilitate better dose delivery and target coverage.

- Large treatment area
- No support mechanism to move or account for in planning
- Low attenuation and surface dose
- Prodigy 2 indexing at 7 cm increments
- 5 Year Warranty
- Dosimetrically Matched* for most major CT, LINAC and Proton models

**VARIAN • ELEKTA • GE • PHILIPS • SIEMENS
CANON • FUJIFILM • IBA • HITACHI • MEVION**

- Self-locking extension seam located outside of treatment field

*Contact your sales representative for more information.

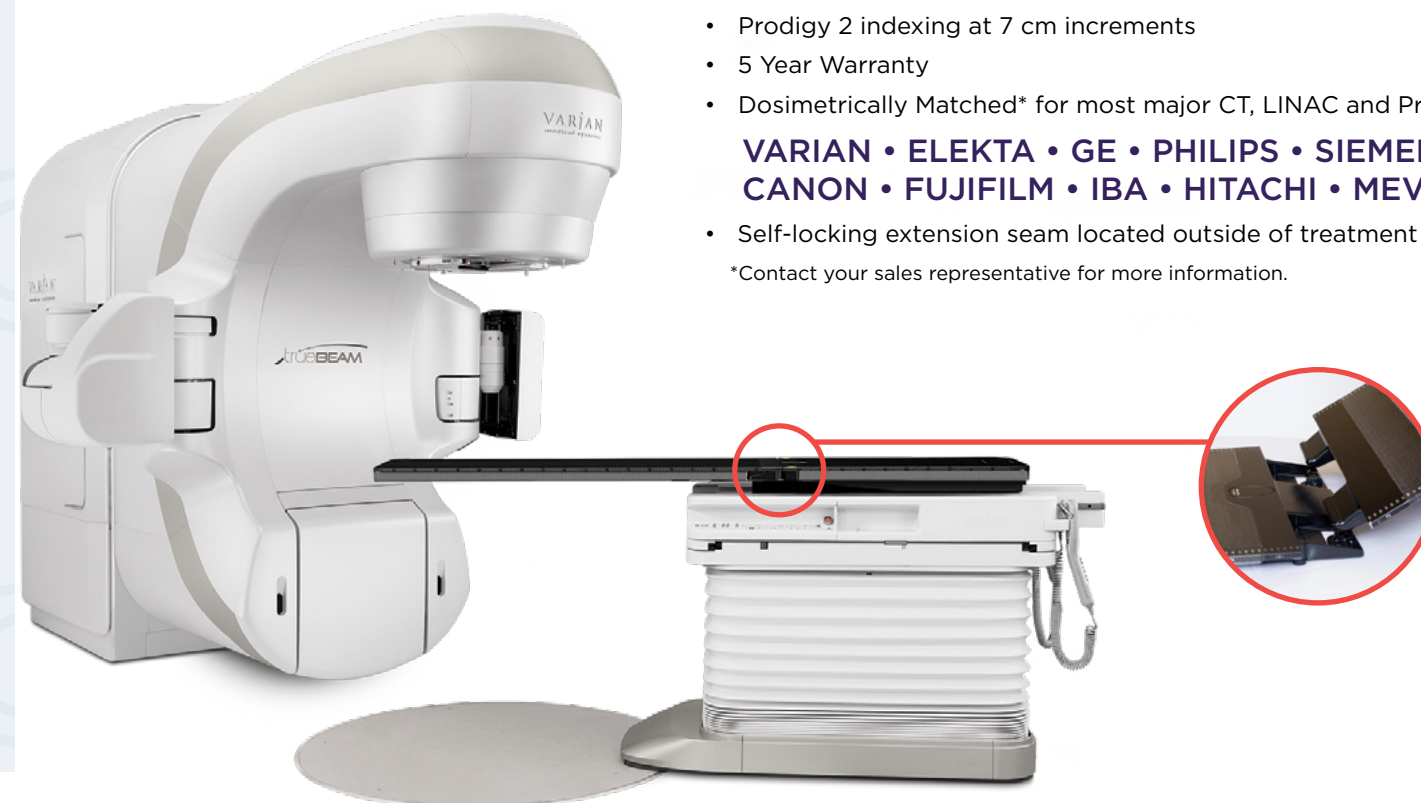

EXTENSIONS ALLOW TREATMENT OF MANY DISEASE SITES

Solstice, Type-S and Posifix Thermoplastics, ONEBridge, Respiratory Belt and many additional solutions attach directly to the Universal Couchtop.



Universal Couchtop Long Extension

CT COMPATIBILITY

GE Discovery ST	MTIL6341
GE VCT1700	MTIL6342
GE VCT 2000	MTIL6343
GE HiSpeed	MTIL6341
Philips Brilliance	MTIL6440
Siemens Biograph	MTIL6042
Siemens Definition MPT Cradle	MTIL6045
Siemens Definition PHS 1 A/B Cradle	MTIL6044
Siemens Definition PHS 4	MTIL6046
Siemens Biograph mCT	MTIL6049
Siemens SOMATOM go.platform, X.cite, X.ceed (Vario2)	MTIL6048
Siemens SOMATOM go.platform, X.cite, X.ceed (VarioRT)	MTIL6047
Canon Aquilion (formerly Toshiba)	MTIL6540
Canon Aquilion One (formerly Toshiba)	MTIL6541

LINAC COMPATIBILITY

Varian TrueBeam Package	MTIL6142*
Includes 53.1" (134.9 cm) Rectangular Extension, Prodigy 2 Lok-Bar, End Plate for Varian (MTIL6612), TrueBeam Reference Device (MTIL6151), Reference Lok-Bar, Wall Storage Device and mounting hardware	
Varian Exact couch for Clinac and Trilogy Systems	MTIL6140
Varian Exact couch for Clinac and Trilogy Systems with Protura	MTIL6141
Elekta	MTIL6240
Siemens TXT or Protura	MTIL6040

All part numbers include UCT LE Couchtop with 53.1" (134.9 cm) Rectangle Extension, Prodigy 2 Lok-Bar and Wall Storage Device (MTIL6100SU, holds one extension). Pedestal side only purchasing options are available. Please contact your sales representative for more information. For proton compatibility, see page 208

Universal Couchtop 1 Piece

The Universal Couchtop 1 Piece is an ideal IGRT and SBRT solution with a uniform design and no junctions. This couchtop offers a dosimetrically matched couchtop for most major CT and LINAC models.

CT COMPATIBILITY

GE Discovery ST	MTIL6321
GE Global 1700	MTIL6322
GE Global 2000	MTIL6323
GE HiSpeed	MTIL6320
Philips Brilliance	MTIL6420
Siemens Biograph	MTIL6022
Siemens Biograph mCT	MTIL6029
Siemens Definition PHS 1 A/B Cradle	MTIL6024
Siemens Definition PHS 4 Cradle	MTIL6026
Siemens SOMATOM Sensation	MTIL6023
Siemens SOMATOM go.platform, X.cite, X.ceed (Vario2)	MTIL6028
Siemens SOMATOM go.platform, X.cite, X.ceed (VarioRT)	MTIL6027
Canon Aquilion (formerly Toshiba)	MTIL6520
Canon Aquilion One (formerly Toshiba)	MTIL6521
FujiFilm FTC Embrace (Contact FujiFilm)	

LINAC COMPATIBILITY

Varian Exact couch for Clinac and Trilogy Systems	MTIL6120
Varian Exact couch for Clinac and Trilogy Systems with Protura	MTIL6121
Elekta	MTIL6220
Siemens TxT or Protura	MTIL6020

*Universal Couchtop Long Extensions have been validated on TrueBeam, VitalBeam & Edge. Legacy CQ Medical positioning and immobilization devices have not been validated with TrueBeam, VitalBeam or Edge and Varian is not liable for use of these products. Universal Couchtop has not been validated on HyperArc™.

Universal Couchtop Extension Options

Rectangular Extensions

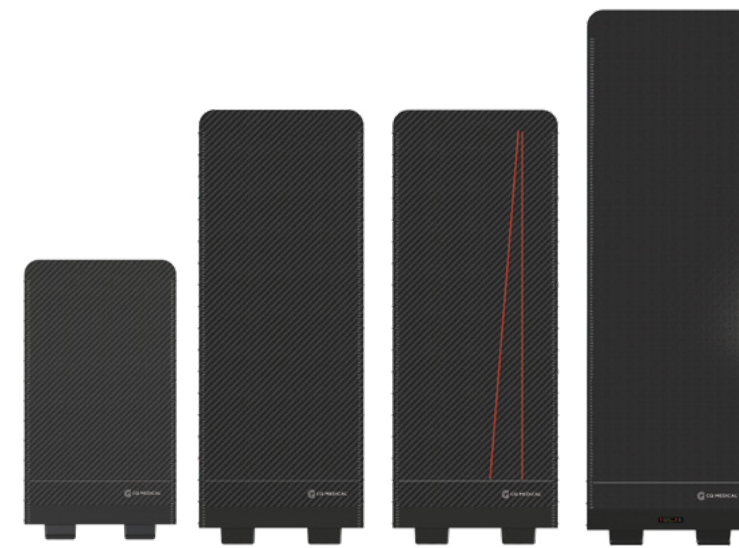

MTIL6669	36.6" (92.9 cm) Short Extension helps manage overall couchtop length when extending overlays past the end of the couch.
MTIL6660*	53.1" (134.9 cm) Standard Extension
MTIL6661*	53.1" (134.9 cm) Extension w/ embedded wires (shown in red) provides additional verification to ensure the patient is correctly aligned under LINAC isocenter relative to table position.
MTIL6676	64.9" (164.8 cm) Extension, CT
MTIL6673	64.9" (164.8 cm) Extension See page 208

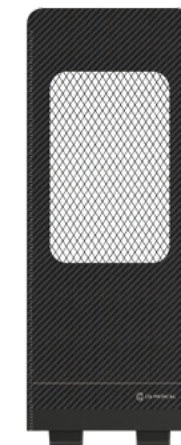

Grid Extension

Helps minimize surface dose and skin reactions.

MTIL6663*	53.1" (134.9 cm)
-----------	------------------

*Universal Couchtop Long Extensions have been validated on TrueBeam, VitalBeam & Edge. CQ Medical positioning and immobilization devices have not been validated with TrueBeam, VitalBeam or Edge and Varian is not liable for use of these products. Universal Couchtop has not been validated on HyperArc.

Universal Couchtop Extension Options

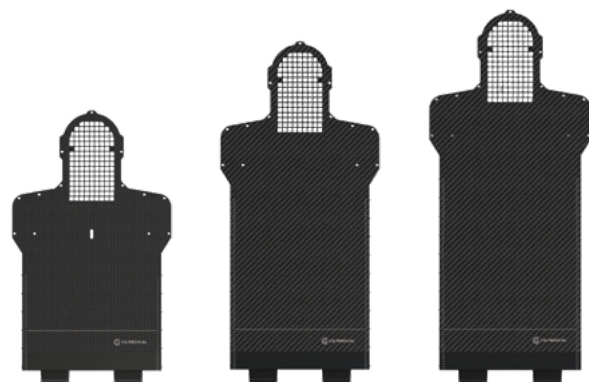

Type-S Extensions

Allows for direct attachment of Solstice SRS and Solstat Immobilization Systems and all Type-S Thermoplastics, including the ClearVision open face mask designed for use with vision/camera systems.

49.1" and 53.1" Extensions do not have a central Vac-Lok point, therefore provides a larger unobstructed treatment region.

MTIL6665	39.1" (99.3 cm)
MTIL6670*	49.1" (124.7 cm)
MTIL6664	53.1" (134.9 cm)



Posifix Extensions

Allows for direct attachment of Solstice SRS and Solstat Immobilization Systems and Posifix Thermoplastics.

MTIL6666	39.1" (99.3 cm)
MTIL6672*	49.1" (124.7 cm)

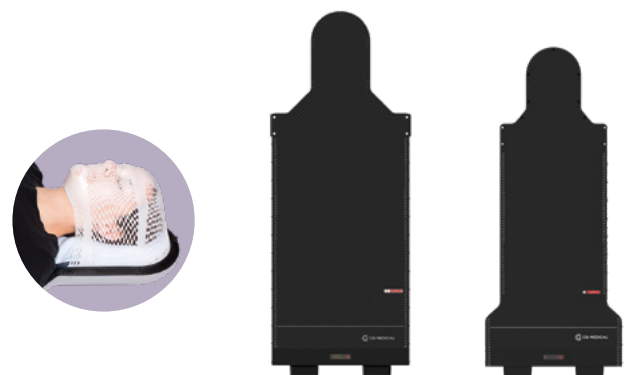

ProForm Extension

Designed for the unique requirements of proton therapy. May also be used for photon treatment.

Additional lengths available, see page 209.

MTIL6675K	53.9" (136.9 cm), includes cushion forming guide and patient handles
MTIL6682K	Pediatric, 48.7" (123.7 cm), includes cushion forming guide and patient handles

Universal Couchtop Accessories



Patient Handles

Clamp to the Universal Couchtop, providing a stable place for immobilized patients to place their hands.

MTIL662501	Right handle
MTIL662502	Left handle



UCT Head Extension

Secures to any UCT via a Prodigy 2 Lok-Bar allowing an additional 17 cm of treatment area.

MTIL6617	
----------	--

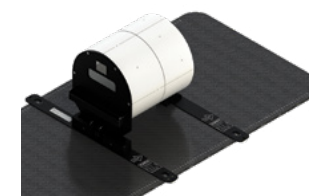

Varian MPC IsoCal Phantom Mount

MTIL6152	Compatible with software version 2.7 and 3.0
----------	--



End Plates for Varian

Allows for use of QA devices

MTIL6667	Interface Extension (attaches to UCT LE junction, left photo) Compatible with MTIL6140, MTIL6141
MTIL6612	Interface Sleeve (slides onto end of Rectangular Extensions, excluding Grid, right photo) Compatible with MTIL6140, MTIL6141, MTIL6142 ,MTIL6120 ,MTIL6121

*Universal Couchtop Long Extensions have been validated on TrueBeam, VitalBeam & Edge. CQ Medical positioning and immobilization devices have not been validated with TrueBeam, VitalBeam or Edge and Varian is not liable for use of these products. Universal Couchtop has not been validated on HyperArc.

kVue™ Couchtops & CT Overlays

KVUE THE BEST OF BOTH WORLDS

One couchtop, multiple treatment solutions, the kVue is a state-of-the-art radiotherapy couchtop optimized for the most recent advances in technology to guide your patient from simulation through treatment. The kVue CT Overlay accepts the same inserts as the kVue Couchtop. This provides the potential for more accurate dose planning and delivery (AAPM TG176).

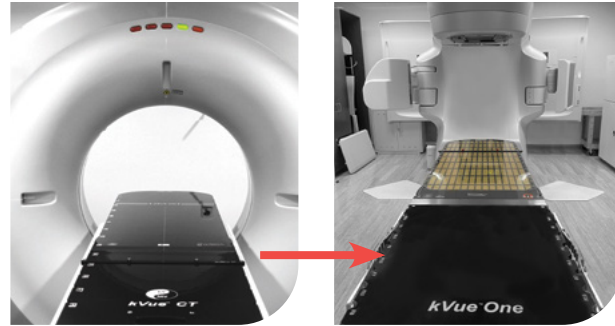

ONETOUCH™ LATCH

Designed and rigorously tested for precision attachment to a variety of kVue inserts. It allows secure attachment and quick detachment with kVue inserts.

Validated with kVue inserts

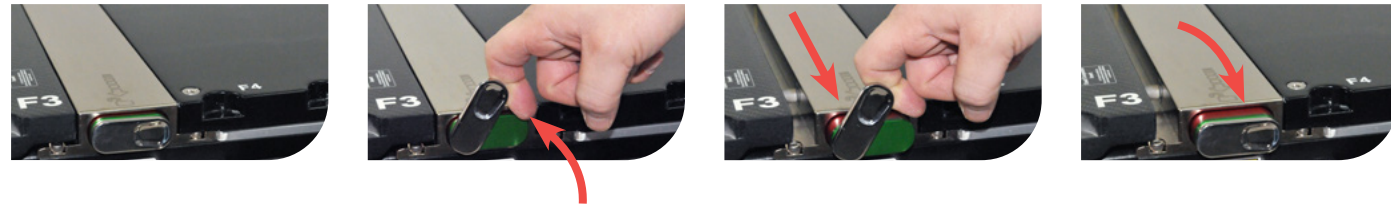
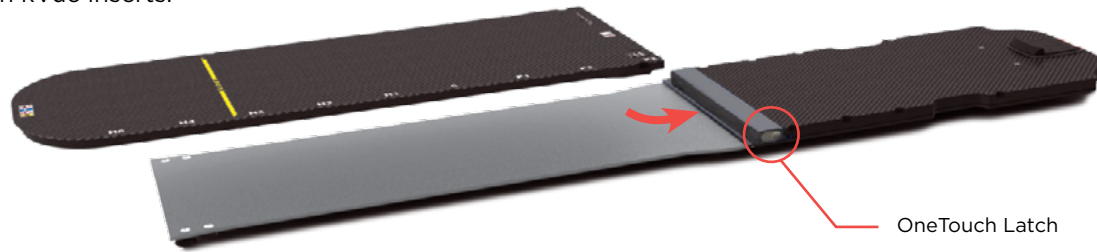

kVue Accessories



kVue Insert Docking Plate

Provides greater flexibility for standardizing the use of kVue Inserts in multiple modalities through the use of this docking plate and two pin locating bars.

RT-4550KVQ



Couchtop Service Panel

Mounts on any kVue Couchtop or couchtop with Varian Style Indexing to protect the couchtop surface during service or maintenance. This product is transparent.

RT-4551SRV

kVue One Couchtop

The kVue One Couchtop is a one-piece modular design with a homogeneous composite base and no moving rails. It offers the ability to interchange treatment specific kVue inserts that mount directly into the top surface of the couch through the One Touch Latch. The light weight kVue One is compatible with versions of 6 Degrees of Freedom (DOF) linear accelerators and robotic bases. (5 mm WET without kVue Insert)

RT-4551KV-01 kVue One Couchtop Base Frame without moving rails (Back Panel included. Requires an insert to function.)

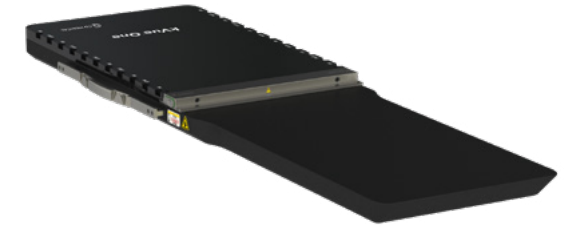

OneTouch Latch

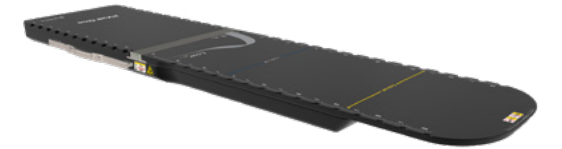

kVue One Couchtop (shown with RT-4551KV19 kVue Low-e Insert)

kVue Couchtop

- Easily adapts to patient and treatment specific needs through the use of interchangeable kVue Inserts
- Inserts mount directly to the couchtop through the OneTouch Latch
- Moving rails can be moved laterally and independently according to treatment plan and imaging requirements

RT-4551KV kVue IGRT Couchtop Base Frame with moving rails (requires an insert to function)

RT-4551KV0 kVue Indexing Back Panel with Varian Exact compatible indexing (not pictured)

RT-4551KVA-ELK Interface plate for Elekta, required for Elekta Couch installations (not pictured)

RT-4551KVVHRD Hardware Kit for Varian Exact Couch, required for Varian Exact installations

RT-4551KVTBHRD Hardware Kit for Varian TrueBeam Pedestal

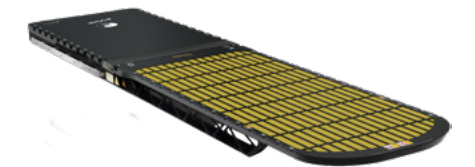

kVue Couchtop (shown with RT-4551KV18 kVue DoseMax Insert)

kVue Insert Options

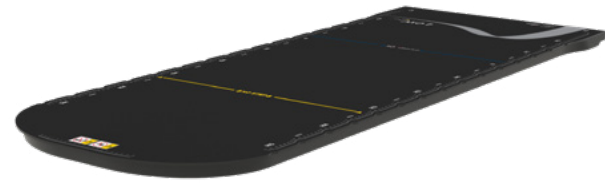

kVue Low-e™ Insert

A low electron generating, homogeneous insert for enhanced imaging and treatment. It is the optimal choice for a wide range of radiotherapy treatments.

RT-4551KV19 Includes Calypso Compatible Locating Bar

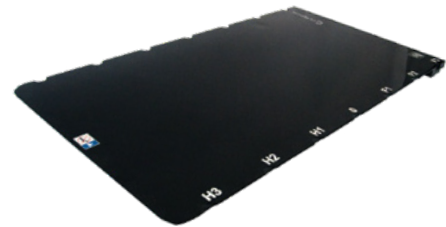

kVue Short Insert

A shorter flat panel insert that allows the kVue to be retracted so that extended head and neck devices can be placed at isocenter.

RT-4551KV2 Includes Locating Bar

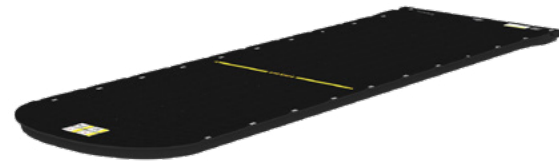

kVue 1610 mm Standard Insert

A versatile, homogeneous insert for enhanced imaging and treatment. It is the optimal choice for for proton therapy.

RT-4551KV13 Includes Locating Bar



kVue Universal Tip Insert

Allows mounting of quality assurance and treatment devices and provides universal mounting capability for some Varian Exact® style tip accessories.

RT-4551KV8 Includes Locating Bar

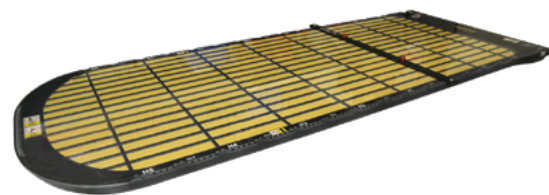

kVue DoseMax™ Insert

Low electron generating insert combines the rigidity of a solid panel insert with skin-sparing properties comparable to a grid panel insert.

RT-4551KV18 Includes Locating Bar

RT-4551KV5F Replacement Film Skin for kVue DoseMax Insert - 3 pack

kVue Insert Options



kVue Encompass SRS Insert

A highly specialized, non-invasive immobilization solution for stereotactic radiosurgery. Encompass is validated for use with Varian HyperArc. See page 71 for more information.

RT-4600KV-01 Includes Encompass Headrest EO & Hand Grip Array

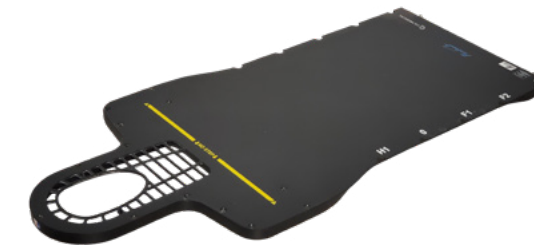

kVue Portrait Intracranial, Head & Neck Insert

Provides superior immobilization for a variety of brain and head and neck radiotherapy treatments. See page 91 for more information.

RT-4552KV Includes Locating Bar



kVue Pronumbra Insert **NEW!**

The next generation of proton head & neck immobilization is here. The Pronumbra system's conformal design ensures the most effective treatment beam angles. Pronumbra offers stunning improvements compared to the legacy BoS system. See page 203 for more information.

RT-4635KV-100 130 cm Insert Package. Includes Insert, Neck Supports (40, 50, and 60 mm), Helping Hands Cushion Manager, Shoulder Adapters, InfinityLock Hand Grips, and Locking Locating Bar.



kVue Bos Inserts

Specifically designed to meet the unique requirements of proton therapy for patient immobilization and beam transmission. It is engineered to rigidly support the patient without using a flat base that blocks the use of proton beam angles. See page 205 for more information.

RT-4535KV Standard Length (1320 mm)

RT-4535KV01 Shorter Length (1210 mm)

RT-4535KV03 Longer Length (1580 mm)

kVue Access 360 G2 Prone Breast Insert

NEAR 360 DEGREE TREATMENT ACCESS

Designed to allow breast cancer treatment for both left and right breast, including whole breast, partial breast and accelerated breast treatments. The sleek, cantilevered design provides both oblique and non-coplanar access, potentially enabling higher dose per fraction. Since the beam path is primarily through the breast with minimal couchtop interference, artifacts and scattering may be minimized.



EXPANDED SUPRACLAVICULAR ACCESS

The thinner, wider grid window provides full access to treat the supraclavicular nodes. The supraclavicular access allows patient treatment in one setup if desired.



kVue Access 360 G2 Package

RT-4544KV-10 Includes Left & Right Inserts, Prone Headrest, Contour Headrest, 2 Hand Grip Posts, Dual Hand Grip, CT Risers, CT Shims, Storage Cart

RT-4544KV-13 Access 360 G2 Treatment Room Extender Package (without CT Risers and Shims)

See page 166 for Prone Breast VacQfix Cushions



Left & Right Inserts

Prone Headrest

Contour Headrest

2 Hand Grip Posts

Dual Hand Grip

CT risers and 2 CT shims

Storage Cart

kVue Virtual Indexing™

An array of white fiducial markers is placed down the center of the couch. The markers are located in line with the center of each indexing notch. A second array of fiducial markers are offset laterally to designate the superior or inferior location of the markers in relation to the indexing origin. This makes it easy to identify the indexing location on your image.

- Quickly ensures treatment couch is in the same position as the simulation couch—every time
- Enables more accurate and faster workflows
- Virtual Indexing is available on most couchtops, CT overlays, and many devices

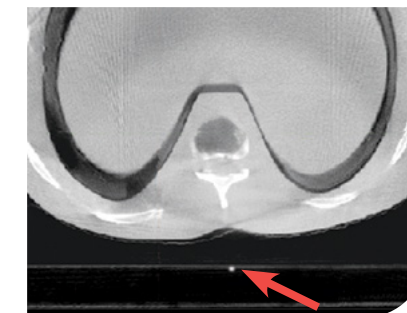

Works with most X-ray techniques such as cone beam CT



KVUE CT OVERLAY FOR

PART

CANON (FORMERLY TOSHIBA)

Canon Aquilion CT Scanner (for 2150 mm long cradle)

RT-4550KVTAQ

Canon Aquilion Scanner (for 2440 mm long cradle)

RT-4550KVTAQ2

GE

GE LightSpeed and HiSpeed CTi CT Scanners (for 2310 mm long cradle)

RT-4550KVGEL

GE LightSpeed RT CT Scanner (for 2070 mm long cradle)

RT-4550KVGER

GE LightSpeed VCT Scanner (for 2620 mm long cradle)

RT-4550KVGEC

PHILIPS

Philips Spectral CT 7500 (for 2450 mm long cradle)

RT-4550KVPH01

Philips Brilliance CT Scanner (for 2500 mm long cradle)

RT-4550KVPBR

Phantom Holder for Philips

RT-4550KVPBRPM

SIEMENS

Siemens SOMATOM Confidence, SOMATOM Drive and SOMATOM Edge Plus (MPT, MPT2n or Vario 2 Table)

RT-4550KVSS3

Siemens PHS1B or Vario RT Table

RT-4550KVSS4

Siemens Biograph

RT-4550KVSS5

Phantom Holder for Siemens

RT-4550KVSSPM

QUANTUM™ CT Overlays

QUANTUM CT Overlay, a flat, indexed surface for RT simulation, offering precise positioning and Varian Exact Indexing. It is thin, lightweight, and narrower than most overlays, providing increased usable bore space. The carbon fiber skin and foam core construction ensure minimal artifacts and superior imaging quality.

- Virtual Indexing is available on most couchtops, CT overlays, and many devices.



QUANTUM CT OVERLAY FOR	PART #
CANON (FORMERLY TOSHIBA)	
Cartesion CT Cradle (for 2780 mm long cradle) Celesteion CT Cradle (for 2780 mm long cradle)	RT-4550CN01
Aquilion Scanner (for 2150 mm long cradle)	RT-4550TAQ
Aquilion Scanner (for 2440 mm long cradle)	RT-4550TAQ2
FUJIFILM	
FCT Embrace	RT-4550FE
GE	
HiSpeed (for 2190 mm long cradle)	RT-4550GEH
HiSpeed CTi (for 2310 mm long cradle)	RT-4550GEL
ProSpeed (for 2070 mm long cradle)	RT-4550GEP
LS VCT (for 2620 mm long cradle)	RT-4550GEC
GT1700 & NG2000V	RT-4550GER2
PHILIPS	
Brilliance (for 2500 mm long cradle)	RT-4550PBR
SIEMENS	
Siemens SOMATOM Confidence, SOMATOM Drive and SOMATOM Edge Plus (MPT, MPT2n or Vario 2 Table)	RT-4550SS3
Siemens PHS1B or Vario RT Table	RT-4550SS4
Biograph	RT-4550SEA

Call for more details. Lead times may vary.

CT Overlays

Carbon fiber one piece overlays securely lock onto a cradle, providing a surface consistent with treatment couchtops. They are lightweight and durable, allowing them to be easily removed or reinserted for use on imaging machines.

- Made of carbon fiber with a foam core
- Two-pin Lok-Bars allow positioning devices to be indexed to couchtop (14 cm intervals)

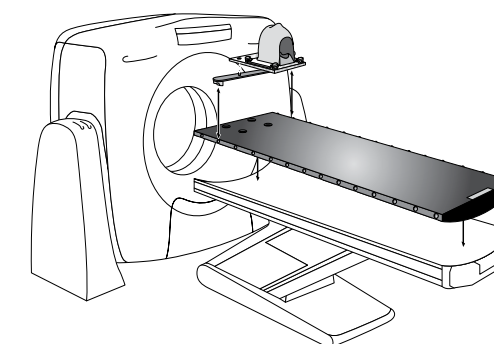

The following CT Overlay options are available; part numbers include 1 standard Lok-Bar:

CT OVERLAY FOR	PART #	INDEXING STYLE	COMPATIBLE LOK-BAR	COMPATIBLE TRANSVERSE LOK-BAR
CANON (FORMERLY TOSHIBA)				
Aquilion (Short)	MTIL3704	Interloc	MTIL3151	MTIL3152
Aquilion (Long)	MTIL3705	Interloc	MTIL3151	MTIL3152
GE				
HiSpeed Advantage, HiSpeed CT/i, LightSpeed QX/i	MTIL3300	Interloc	MTIL3151	MTIL3152
Discovery ST (H-Power Base)	MTIL3310	Interloc	MTIL3151	MTIL3152
LightSpeed VCT Discovery ST (Global Base)	MTIL3311	Prodigy	MTIL3653	MTIL3652
SIEMENS				
SOMATOM Sensation (after Aug 2004)	MTIL3013	Prodigy	MTIL3653	MTIL3652
SOMATOM Definition (PHS4 cradle)	MTIL3019	Prodigy	MTIL3653	MTIL3652
SOMATOM Definition, Emotion, Spirit, Perspective (PHS 1A or 1B cradle)	MTIL3020	Prodigy	MTIL3653	MTIL3652
Biograph	MTIL4101	Interloc	MTIL3151	MTIL3152

For MR Overlay options, see page 194.

Lok-Bars™



Prodigy™ 2 Lok-Bar

The Prodigy 2 Lok-Bar with 7 cm spacing is for use with all Universal Couchtops and TotalRT Platform.

MTIL6050	Standard
MTIL6053	Fiberglass (recommended for use with UCT LE Kevlar Extension)
MTIL6051	Transverse (allow for offsetting patient laterally on the couchtop)
MTIL6054	MR

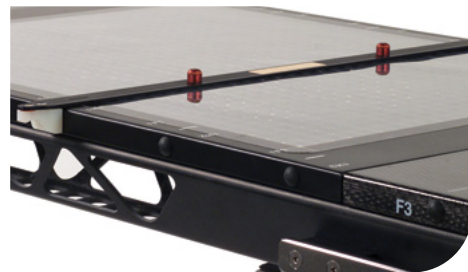

Prodigy Lok-Bar

The Prodigy Lok-Bar with 14 cm spacing is for use with Prodigy style indexed couchtops. The Slim Prodigy Lok-Bar features smaller side profiles.

MTIL3651	for 50 cm wide couchtop
MTIL3653	Slim Prodigy for 53 cm wide couchtop



Interloc® Lok-Bar

The Interloc Lok-Bar with 14 cm spacing is for use with Interloc style indexed couchtops.

MTIL3051	for 49.5 cm wide couchtop
MTIL3850	for 50 cm wide couchtop
MTIL3151	for 53 cm wide couchtop



Exact® Lok-Bar

The Exact Lok-Bar with 14 cm spacing is for use with Exact or Interloc style indexed couchtops.

20VARSUB10	for 53 cm wide couchtop
------------	-------------------------

Lok-Bars



Transverse Lok-Bar

The Transverse Lok-Bar allows for lateral movement of the two-pin system across the couchtop, providing more options in positioning the patient on the couchtop. The Transverse Lok-Bar is available in Prodigy, Prodigy 2, Interloc, PinnPoint™, Exact and Medical Intelligence indexing styles.

MTIL3152	Interloc, 53 cm
MTVAR46	Exact, 53 cm
MTIL3652	Prodigy, 53 cm
MTIL6051	Prodigy 2, 53 cm
MTIL3950	Medical Intelligence

Slide Guide Lok-Bar

The Slide Guide Lok-Bar does not lock down to the indexing points along the couchtop but slides longitudinally along the couchtop. It is designed to prevent lateral movement and is useful for longer devices such as bellyboards, breastboards and Vac-Lok Cushions, which contract during forming.

MTVL00853	Standard, 40-53 cm
MTIL1006	Transverse, 48-53 cm

Slide Guide Two-Pin Lok-Bar

The Slide Guide Two-Pin Lok-Bar slides longitudinally along the Universal Couchtop profile without being limited to any indexing points. It is designed to prevent lateral movement and is useful for longer devices such as bellyboards, breastboards and Vac-Lok Cushions, which contract during forming.

MTIL6058	Prodigy 2, 53 cm, MR Safe
----------	---------------------------

MR Lok-Bar

MR Lok-Bars allow indexing of positioning devices to a MRI couchtop. Always refer to product labeling to identify whether a device is MR Safe or MR Conditional.

See pages 190-198 for MRSeries.

MTIL3351	Interloc 50 cm
MTIL3352	Interloc 53 cm
MTIL3454	Prodigy 50 cm
MTIL6054	Prodigy 2, 53 cm
MTULB001	Elekta Unity MR-LINAC



Locating Bars



Locating Bar

This Locating Bar is compatible with Varian Exact Style indexing including kVue Couchtops and Alta Multipurpose Device.

RT-4551BAR



MR Safe Locating Bar

This Locating Bar is compatible with Varian Exact Style indexing including kVue Couchtops and Alta Multipurpose Device.

See pages 190 – 198 for MRSeries.

RT-4551BARMRI



Locking Locating Bar

This Locating Bar is compatible with Varian Exact Style indexing including kVue Couchtops and Alta Multipurpose Device.

RT-4551BAR-05



Transverse Locating Bar (Sliding)

The two indexing pins can be offset by 100 mm either left or right for increased flexibility of positioning an immobilization device and accessory setup, which is ideal for breast and SBRT treatment setups. They are compatible with Varian Exact Style indexing including kVue Couchtops and Alta Multipurpose Device.

RT-4551BAR-01



QA Locating Bar

Compatible with Varian Geometric Phantom.

RT-4551BAR-03



Elekta Style Locating Bar

Locating bar for Elekta style indexed couchtops.

RT-4551BAR-04

SofTouch Couchtop Pads

SofTouch Couchtop Pads

Supportive and comfortable for patients during a variety of radiotherapy procedures. They are available in multiple lengths and thicknesses.

RT-4488-04 1.9 x 50 x 180 cm

RT-4488-03 0.6 x 50 x 180 cm

RT-4488-02 1.9 x 50 x 100 cm

RT-4488-01 0.6 x 50 x 100 cm

SofTouch Couchtop Pads have a 90-day warranty from date of purchase. Foam products will vary in size due to manufacturing, storage, and use conditions. They are intended for patient comfort purposes only. Dimensions are for reference only.



A yellow hard hat is centered in the background of the page. The word "FACT:" is overlaid on the left side of the hard hat in a large, bold, dark blue font.

FACT:

Healthcare workers suffer more injuries on the job than construction workers.*

That was the inspiration for creating our **Symphony® AirShuttle™ with AirDrive™ patient transfer system**. With minimal staff and effort, a patient can be safely transferred from one treatment, procedure, or imaging surface to another without having to reposition the patient. We think that's a pretty smart way to take care of all involved.



Symphony[®] Imaging, Treatment & Transfer Solution



Symphony Solutions AirShuttle & AirDrive Options

A Symphony radiation oncology solution combines an AirShuttle patient platform with an AirDrive system to provide smooth patient transfers between imaging modalities and treatment platforms. A Symphony solution is utilized in imaging modalities including CT, MRI (up to 3 Tesla), ultrasound, and treatment environments including brachytherapy, photon, and proton.

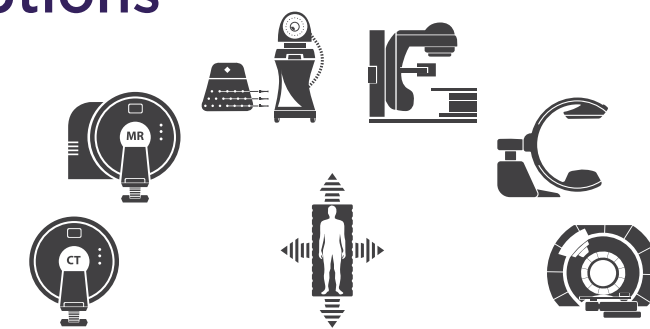

AirShuttle + AirDrive

- Safely transfer your patient with minimal clinical staff
- Transfer on and off a wide variety of surfaces including sheet-covered pads and mattresses
- Fully indexable to couchtop, and immobilization & positioning devices can be indexed to the AirShuttle
- Suitable for use in MRI

AirShuttle

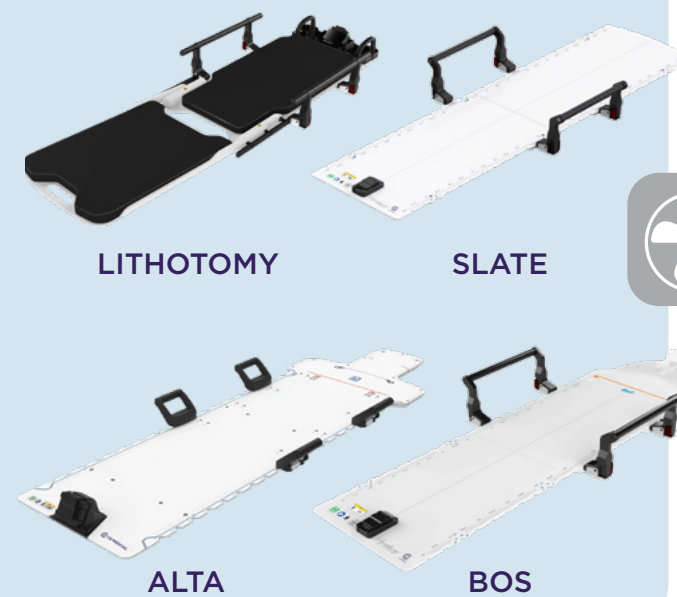

AirDrive



COMPATIBLE MODALITIES AND TREATMENT ENVIRONMENTS



BRACHYTHERAPY HAS COME A LONG WAY.

TOGETHER, WE'LL MAKE REMARKABLE ADVANCEMENTS!

SEE OUR NEW BRACHYTHERAPY PRODUCT SECTION, PAGES 35-39!

Alpine™ Stirrups



BrachyGel™

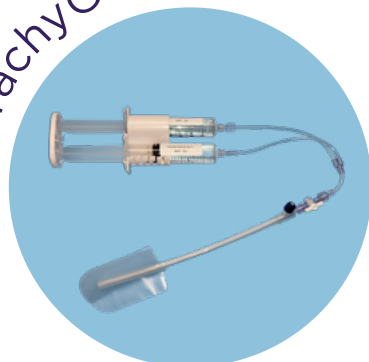

Lithotomy AirShuttle

MAXIMIZE WORKFLOW EFFICIENCY

The patient is positioned once on the Lithotomy AirShuttle prior to insertion and then transferred easily, safely, and comfortably for imaging, treatment, and recovery.

- Integrated surgical rails are compatible with CT and MR imaging and allow stirrups, steppers, and other accessories to be quickly attached
- The leg extension supports the patient's legs for transfers and imaging and is easily removed to provide access to the perineum
- Provides stable patient support and reduced patient motion during transfers
- Clinicians report reduced applicator motion and improved patient comfort when using AirDrive technology over conventional patient transfers
- Patient transfers are performed with only two people, reducing staffing needs and allowing team members to focus on other responsibilities
- Removable, cleanable pads on the transfer device provide patient comfort from insertion through treatment
- Transfers laterally and longitudinally

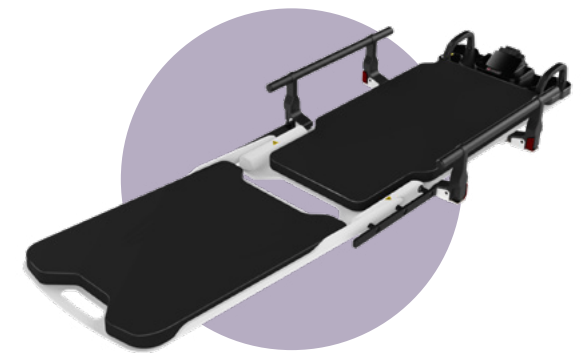

INSERTION CAN BE PERFORMED DIRECTLY ON TROLLEY



Lithotomy AirShuttle with AirDrive Trolley



Lithotomy AirShuttle with AirDrive Caddie

Lithotomy AirShuttle Packages

RT-5100-500	w/ AirDrive Trolley. Includes AirShuttle Transfer Handles (x2), Brachytherapy Insertion Overlay, Lithotomy Air Bearing (Spare), IV Pole
RT-5100-500S	w/ AirDrive Caddie. Includes: AirShuttle Transfer Handles (x2), Lithotomy Air Bearing (Spare)

Alta AirShuttle

ELEVATE YOUR WORKFLOW EFFICIENCIES TO A WHOLE NEW LEVEL

All in one solution can be used for a wide range of indications to reduce setup times.

- Combines functionality of multiple devices
- Can be extended beyond end of couchtop
- Dependable and reproducible
- Fast and efficient

Alta AirShuttle Packages

Both packages include: Alta AirShuttle Transfer Handles (x4), Alta ArmShuttle Elite, Silverman Pin Adapter, InfinityLock Hand grips (x2), FlexLock Knee Support, FlexLock Foot Support, MR Safe Locating Bars (x2), AirShuttle Locating Bars (x2), Alta Air Bearing (Spare), Wall Mount

RT-5100-700 w/ AirDrive Trolley

RT-5100-700S w/ AirDrive Caddie

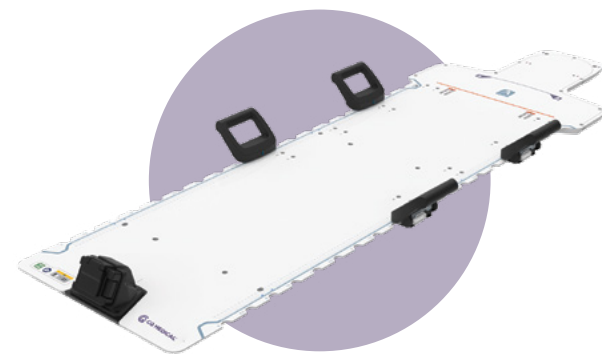

Example Accessories: ZIFix Traverse, SBRT ONEBridge, InfinityLock Compression Bridges

Slate AirShuttle

OUR THINNEST AND LIGHTEST AIRSHUTTLE

The Slate AirShuttle features low attenuation and homogeneity for enhanced imaging and treatment. It can be used in conjunction with existing positioning and immobilization devices, further improving workflow efficiencies.

Slate AirShuttle Packages

Both packages include: AirShuttle Transfer Handles (x2), AirShuttle Locating Bars (x2), Slate Air Bearing (Spare)

RT-5100-100 w/ AirDrive Trolley

RT-5100-100S w/ AirDrive Caddie

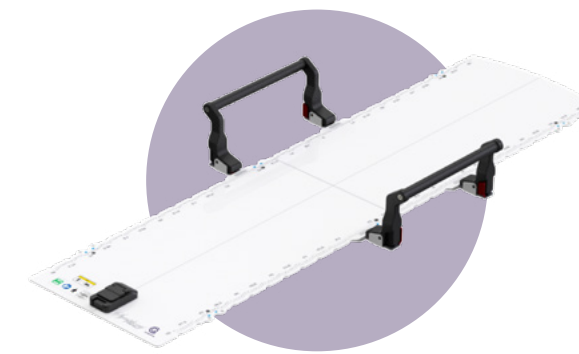

Example Accessories: INSIGHT MRI Coil Holders, FlexLock Knee & Foot Supports, VacQfix Cushions, Locating Bars

BoS AirShuttle

DESIGNED FOR PROTON THERAPY

The conformal shape of the device optimizes the penumbra and minimizes the blockage of important proton beam angles.

BoS AirShuttle Packages

Both packages include: AirShuttle Transfer Handles (x2), AirShuttle Locating Bars (x2), BoS Air Bearing (Spare)

RT-5100-400 w/ AirDrive Trolley

RT-5100-400S w/ AirDrive Caddie



Example Accessories: Foam Headrest, Precut Foam Shim for BoS Headframe, BoS Masks, Locating Bars

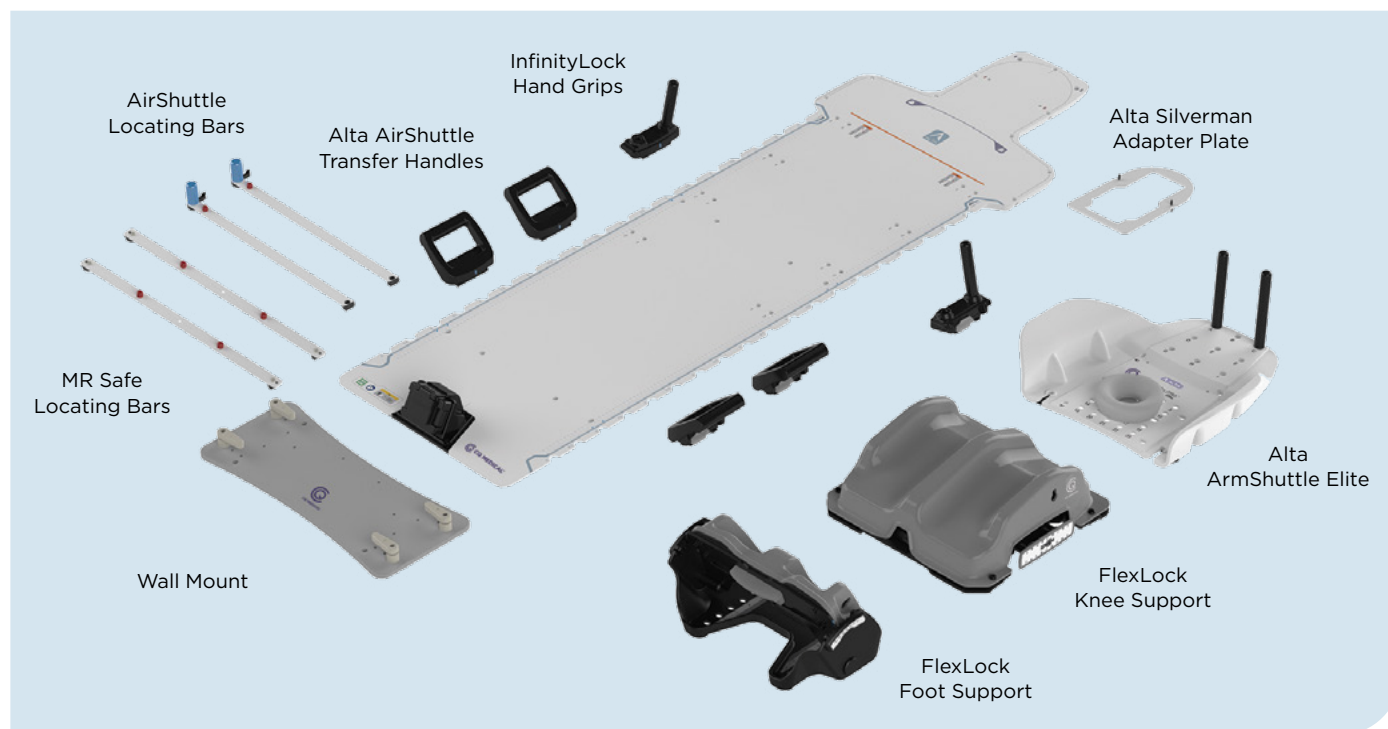

Customized Cancer Care Workflow

- Alta and Slate AirShuttles eliminate the need for patient repositioning between simulation and treatment
- Supports existing positioning & immobilization accessories and devices for lower cost of ownership
- Large, artifact-free, and homogeneous treatment area for precise dose delivery, including hypofractionation



TOTAL BODY IRRADIATION (TBI + VMAT)

- Provides rotational support, allowing a 180-degree patient orientation for both simulation and treatment procedures
- Enables the utilization of multi-isocenter treatment techniques
- Accommodates for patients up to 500 lbs.



ADAPTIVE

- Allows consistent patient positioning from image acquisition through planning and treatment
- Enhances workflow efficiencies by streamlining processes
- Offers support for adaptation in offline, online, and real-time scenarios as required

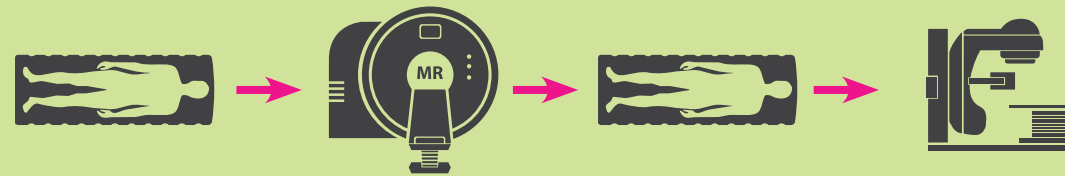

MULTI-SIM

- Allows for a single patient setup that caters to both MR and CT simulations
- Facilitates patient setup and positioning outside of the simulation room
- Beneficial for patients with restricted mobility

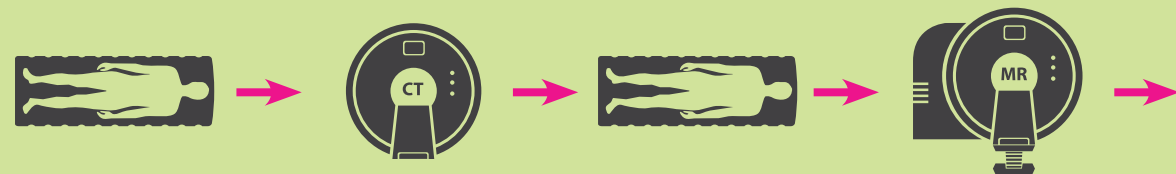

Brachytherapy Solutions



BrachyGel™ Vaginal Hydrogel Packing

NEW!

A PERSONALIZED PACKING SOLUTION

BrachyGel is a personalized packing solution for image-guided brachytherapy and the first of its kind. BrachyGel provides proven stability of brachytherapy applicators through treatment planning and delivery. Unlike gauze or a saline-filled balloon, it contours to the patient's anatomy and reduces air gaps.

- Quick delivery system streamlines your procedures and saves valuable time
- Facilitate a smoother transition from full anesthesia to inpatient care
- Better clinician and patient experience ensure maximum value for healthcare facilities

RT-5300 BrachyGel, Qty 5 kits. Each kit includes hydrogel syringe, y-connector, and 1 therapy bag.

CURRENTLY ONLY AVAILABLE IN THE U.S.



SEE BRACHYGEL IN ACTION

BRACHYGEL ON CT AND MRI



Pelvic Phantom (CT)

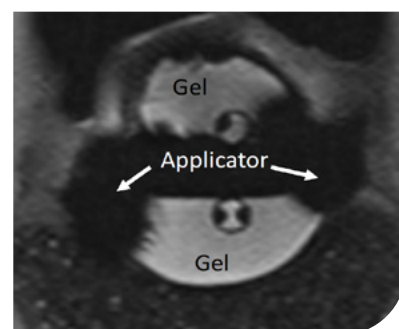

Cadaver (MRI)



Clinical Trial Subject (CT)

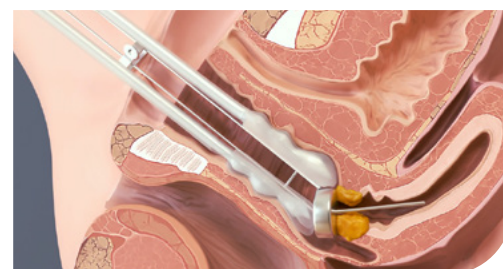
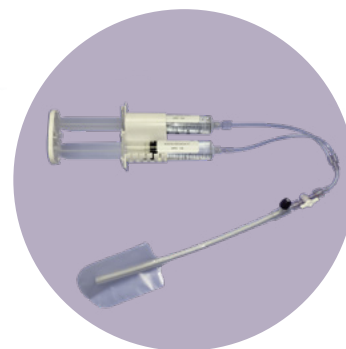

Patient Transfer & Imaging Solutions

An AirShuttle patient platform with an AirDrive system provides smooth patient transfers for imaging and treatment applications. AirShuttles and AirDrives can be used in imaging modalities including CT, X-Ray, ultrasound, fluoroscopy, MRI (up to 3 Tesla), and radiation therapy treatment environments including brachytherapy.

- Safely transfer your patient with minimal clinical staff
- Transfer on and off a wide variety of surfaces including sheet-covered pads and mattresses
- Patient positioning can include immobilization, where required
- Suitable for use in MRI

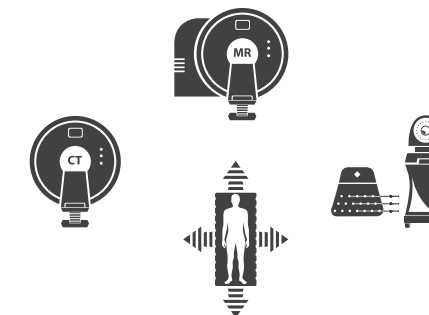

AirShuttle + AirDrive

AirShuttle

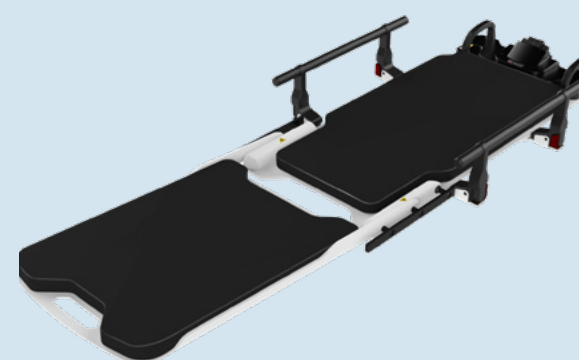

LITHOTOMY

AirDrive



CADDIE

TROLLEY

Brachytherapy Workflow

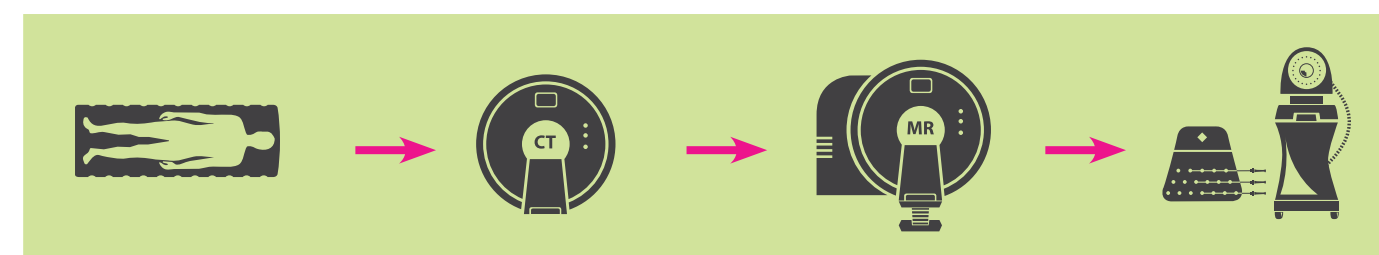

BrachyGel provided favorable OAR dosimetry, solid HR-CTV coverage, and no unexpected adverse events. Physicians and patients both preferred the BrachyGel use experience over standard gauze packing.

DR. KARA ROMANO, MD, UNIVERSITY OF VIRGINIA

RESULTS FROM THE PROSPECTIVE RANDOMIZED NON-INFERIORITY CROSS-OVER TRIAL EVALUATING VAGINAL PACKING FOR CERVICAL CANCER BRACHYTHERAPY.



Lithotomy AirShuttle

MAXIMIZE WORKFLOW FLEXIBILITY

The patient is positioned once on the Lithotomy AirShuttle prior to insertion and then transferred easily, safely, and comfortably for imaging, treatment, and recovery.

- Integrated surgical rails are compatible with CT and MR imaging and allow stirrups, steppers, and other accessories to be quickly attached
- The leg extension supports the patient's legs for transfers and imaging and is easily removed to provide access to the perineum
- Provides stable patient support and reduced patient motion during transfers
- Clinicians report reduced applicator motion and improved patient comfort when using AirDrive technology over conventional patient transfers
- Patient transfers are performed with only two people, reducing staffing needs and allowing team members to focus on other responsibilities
- Removable, cleanable pads on the transfer device provide patient comfort from insertion through treatment
- Transfers laterally and longitudinally

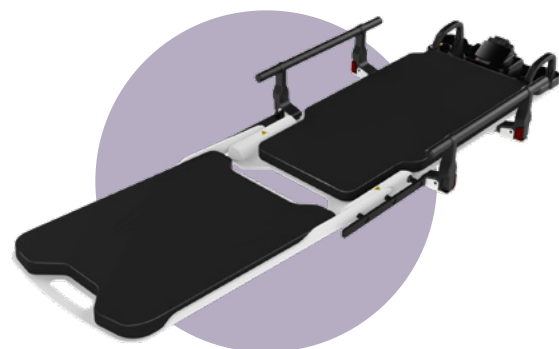

INSERTION CAN BE PERFORMED DIRECTLY ON TROLLEY

Lithotomy AirShuttle with AirDrive Caddie



Lithotomy AirShuttle with AirDrive Trolley



Lithotomy AirShuttle Packages

RT-5100-500	w/ AirDrive Trolley. Includes AirShuttle Transfer Handles (x2), Brachytherapy Insertion Overlay, Lithotomy Air Bearing (Spare), IV Pole
RT-5100-500S	w/ AirDrive Caddie. Includes: AirShuttle Transfer Handles (x2), Lithotomy Air Bearing (Spare)

Alpine™ Stirrups

NEW!

WORKFLOW EFFICIENCIES JUST GOT SMARTER

Alpine Stirrups are meticulously designed and feature an integrated rail clamp for easy attachment and enhanced anatomical access.

- Provide optimal pelvic access while accommodating entry into a 70cm MR bore
- Integrated rail attachment clamp ensures easy setup and prevents the loss of separate components common with standard stirrups
- Intuitive handle facilitates adjustment with minimal effort
- 20% lighter than other standard stirrups on the market (as of 07/2024)
- Smart and comfortable boot design for easy cleaning
- Patient Weight Capacity: 500 lbs
- Stirrup Weight: 10.05 lbs

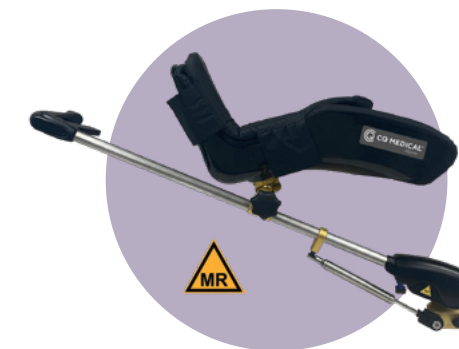

RT-5100-54 Alpine Stirrups (pair)

Applicator Clamp Holder

The Symphony Applicator Clamp Holder provides a safe and effective integrated solution to reduce applicator movement post-insertion. Post mounted or rail mounted versions accommodate various brachytherapy positioning workflows. Both holders are compatible with a wide variety of commercially available brachytherapy applicators. Compatible with CT and MR imaging.

RT-5100-53 Post Mounted Applicator Clamp Holder (left photo)

RT-5100-52 Rail Mounted Applicator Clamp Holder (right photo)

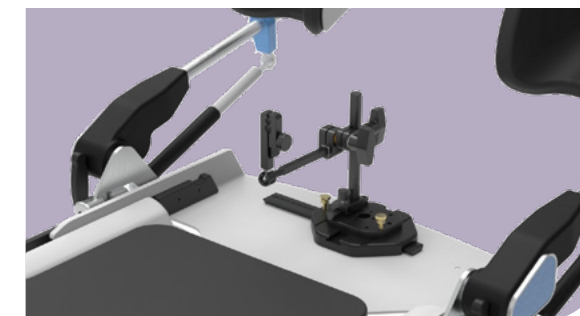

Applicator Clamp shown for demonstration only. Not manufactured or sold by CQ Medical.



Stirrups and SpringLoc Clamp

RT-5100-51ST	Stirrups (pair)
RT-5100-51CU	SpringLoc Clamp, US (each)
RT-5100-51CE	SpringLoc Clamp, Europe (each)



Alta on Halcyon™

All in One Solutions

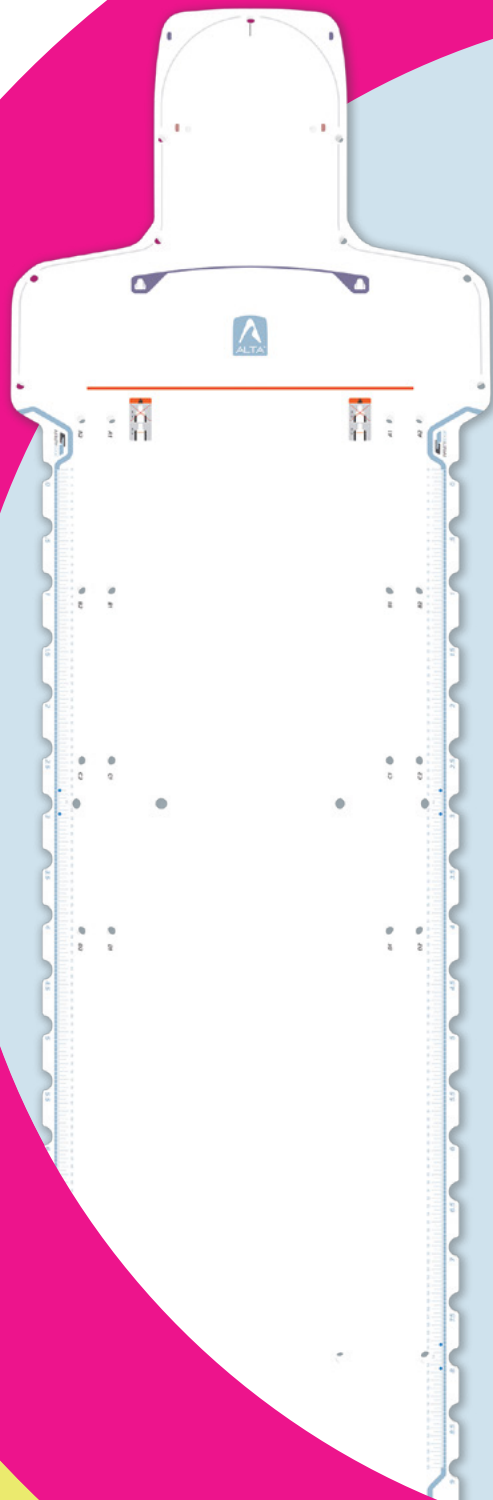

“ Alta has increased our efficiency between patient set ups. We can seamlessly switch between treatment types without delay. Patients are more satisfied and so are the therapists using the system.

CLINTON O'DELL BSRS RT(R)(T), ANMED HEALTH RADIATION ONCOLOGY ANDERSON, SOUTH CAROLINA



Alta™ Multipurpose Device

Alta is an all in one solution that quickly adapts to a wide range of setups, reducing setup times.

- Combines functionality of multiple devices
- Dependable and reproducible
- Fast and efficient setups
- Can be extended beyond end of couchtop for improved head and neck dosimetry
- Lightweight-5.4 kg (12 lbs)
- 610 mm (24 in) W x 1990 mm (78.5 in) L
- MR Safe, CT, and treatment compatible

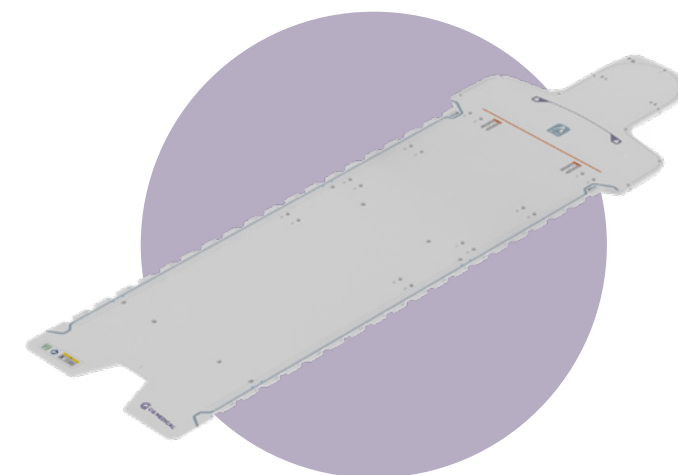

SRS



PELVIS



INTRACRANIAL, HEAD & NECK



ABDOMEN



CRANIOSPINAL



LUNG



WHOLE BRAIN



THORAX



BREAST



SBRT

NEW! ALTA FOR SBRT IS NOW COMPATIBLE WITH BODY PRO-LOK ONEBRIDGE
See page 48 for more information.



Elevate Your Workflow with Alta

INFINITYEDGE™ & INFINITYLOCK™

InfinityLock accessories tightly fasten to the device and can be infinitely indexed along the InfinityEdge of the device.



ALTA ARMSHUTTLE™ ELITE

Quickly and securely attaches to provide comfortable, reproducible positioning of the arms out of the treatment field.



Alta Standard Package

Alta Multipurpose Device	Qty 1
Alta ArmShuttle Elite	1
Alta Silverman Adapter Plate	1
FlexLock Knee Support	1
FlexLock Foot Support	1
InfinityLock Hand Grips	2
MR Safe Locating Bars	2
Wall Mount	1
	RT-4800-100

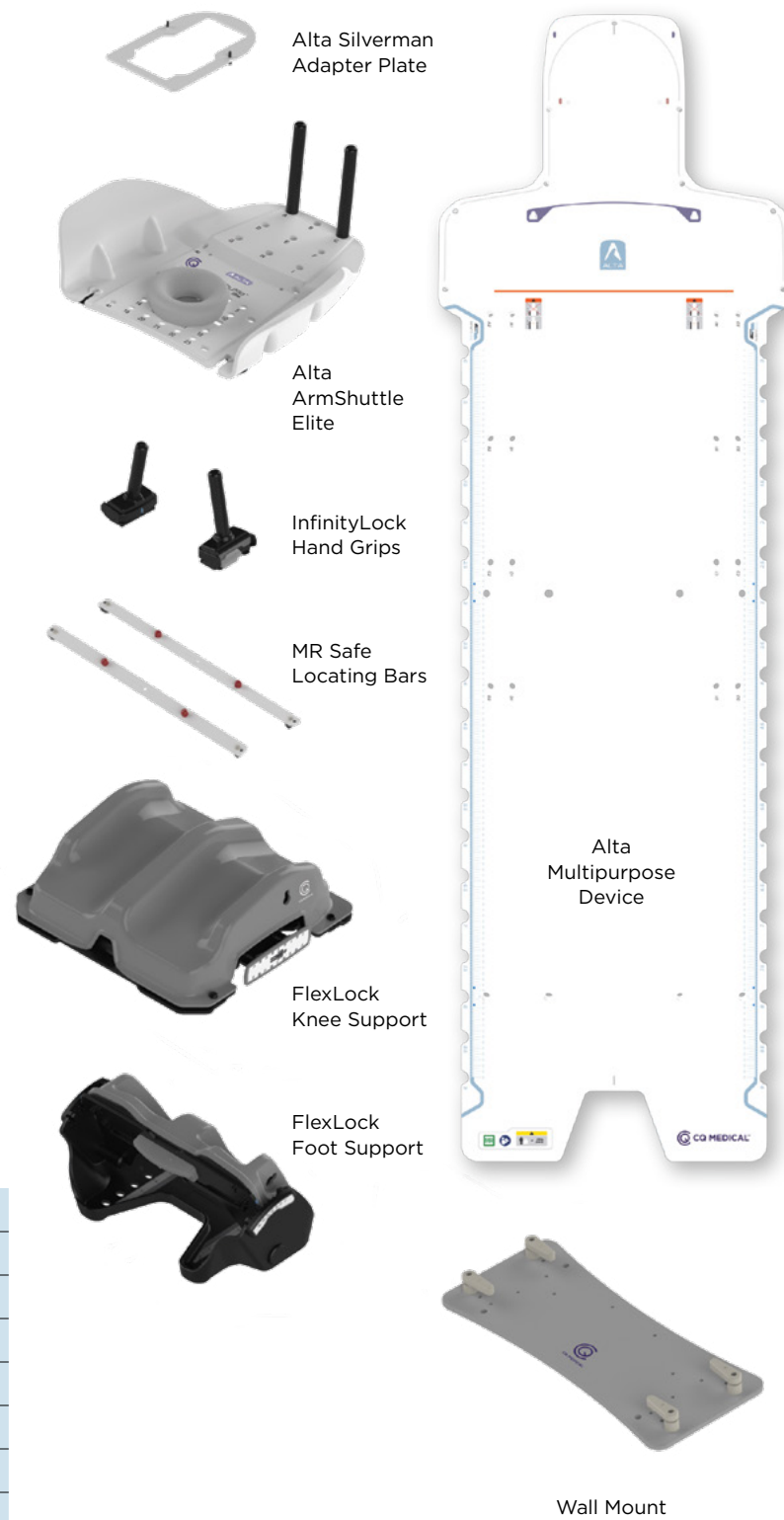

Alta Integration

FLEXIBILITY IN SRS, HEAD & NECK, CRANIOSPINAL, AND WHOLE BRAIN SETUPS

Alta can easily be used as a stereotactic radiotherapy treatment solution through the quick attachment of the SRS Adapter or Solstice SRS Immobilization System. Alta can extend beyond the couchtop to provide improved access to the head and neck region. It is compatible with Type-S thermoplastic masks, which can be directly attached to the device.

For the SRS Adapter, see page 76. For Type-S Head & Neck Solutions, see pages 92-98.



ENCOMPASS SRS

SOLSTICE SRS



HEAD & NECK

CRANIOSPINAL

WHOLE BRAIN

SBRT IMMOBILIZATION

The low electron generating properties of Alta make it a great solution for stereotactic body radiation therapy setups. It can be adapted to apply abdominal compression when used with devices such as ZiFix Traverse, Body Pro-Lok ONEBridge, or InfinityLock Compression Bridges.

For SBRT Solutions, see pages 47-64.

NEW INTEGRATION!



TotalRT™ All in One Platform

INCREASE EFFICIENCY, POSITION DEVICES EASILY AND GAIN CONFIDENCE IN PATIENT SETUP

The TotalRT All in One Platform is designed to quickly adapt positioning and immobilization solutions to your clinical setup and treatment needs. The platform is indexable on a couchtop, creating an affordable all in one solution and allowing seamless transition between patient treatments.

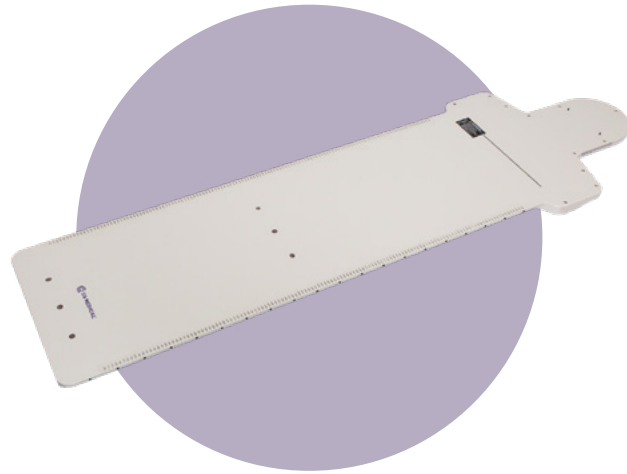

TotalRT All in One Platform

- Easily indexable on CT, MR and photon treatment tables with two Lok-Bars
- Large, artifact-free and homogeneous treatment area for precise dose delivery, including hypofractionation
- Repeatable positioning of positioning and immobilization devices, even between treatment rooms
- A single therapist can carry and index to couchtop
- Wall storage device allows effective way to store and protect the platform
- Lightweight: 7.3 kg / 16 lbs
- Dimensions (cm): 201.3 (L) x 61.9 (W) x 3.5 (H)
- Platform is MR Safe

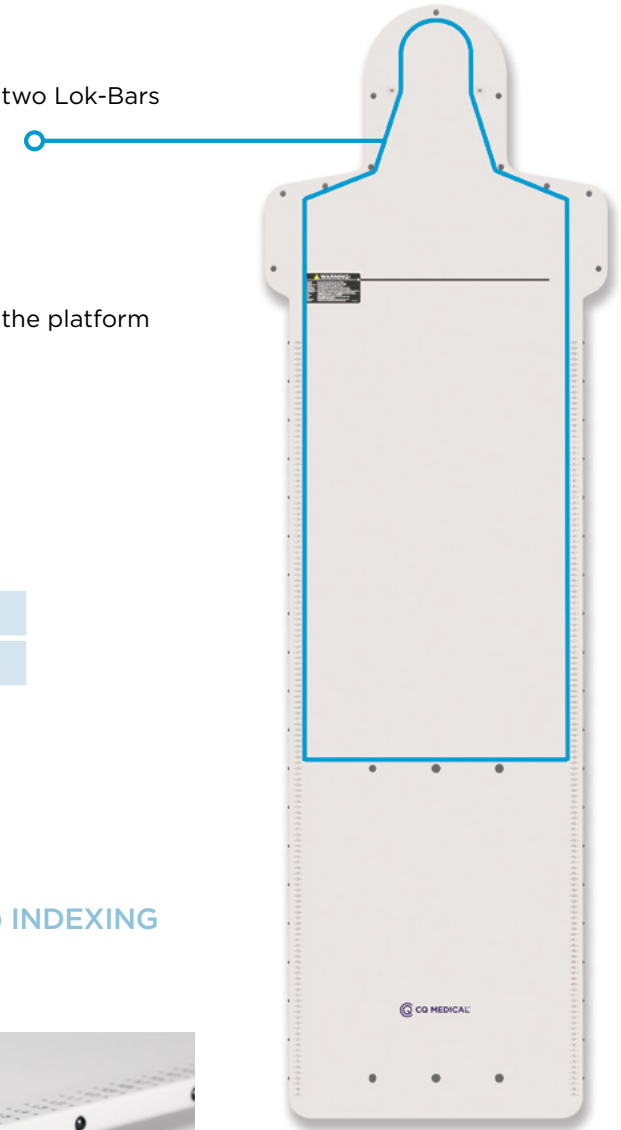

TotalRT Platform

TRT100	201.3 cm, Glass Fiber
MTWBL001	Type-S Lok-Bar

UNIVERSAL COUCHTOP PROFILE, PRODIGY 2 (7 CM) INDEXING

Directly attach devices to the platform or secure using Lok-Bars



ALLOWS USE OF WING BOARDS IN HEAD & NECK AREA

Type-S Lok-Bar allows for indexing of any Three-Pin Wing Board or the Monarch Overhead Arm Positioner



FACT:

The world record to solve a Rubik's® Cube is 3.13 seconds.*

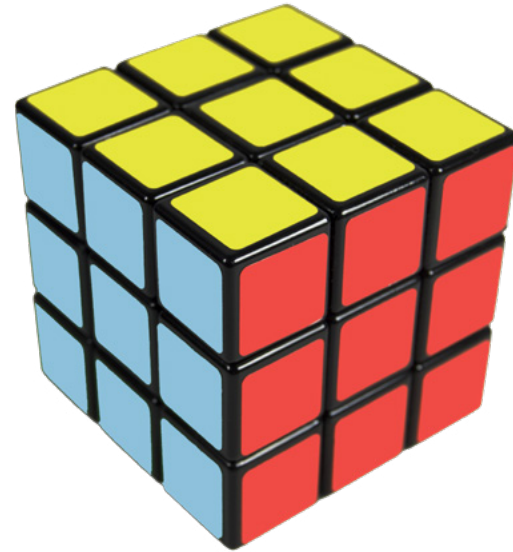

Sometimes, what seems out of reach is possible. In the complex world of lung cancer and SBRT treatment, accuracy, efficiency, and patient comfort are achievable. That was the inspiration for bringing our best SBRT solutions together, including the new compatibility of **Body Pro-Lok™ ONEBridge™ for Alta™ Multipurpose Device** and refining how our **ONE Respiratory Belt** and **ZiFix Traverse™ Motion Control System** attach to our most popular platforms. Also, the new **BioXmark® Liquid Fiducial** allows the implantation of multiple markers of varying sizes in the same uninterrupted procedure.

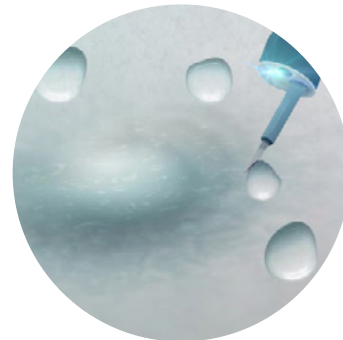

SBRT (STEREOTACTIC BODY RADIATION THERAPY)



Total Body Immobilization for Hypo-Fractionation Treatment

Body Pro-Lok ONE System provides a customizable and reproducible solution for complex SBRT patient setups.



Improved Patient Positioning and Respiratory Restriction

ONEBridge™

- Variable height adjustment with just one bridge
- Lateral offset ability allows the bridge and plate to adapt to the patient's natural posture and body type
- Tilting offset ability allows optimal patient positioning for enhanced gantry clearance
- Advanced latch engineered to release in less than three seconds for patient safety



Respiratory Belt

- Respiratory Belts provide pneumatic compression and immobilization to the abdominal region.

COMING SOON! ONECLAMP ENABLING CROSS COMPATIBILITY OF ZIFIX TRAVERSE AND ONE RESPIRATORY BELT TO ALL ALTA, TOTALRT, AND ONEPLATFORM DEVICES



Devices Easily Connect to Many Platforms

Body Pro-Lok ONE System devices are compatible with many market-leading CQ Medical platforms and couchtops.

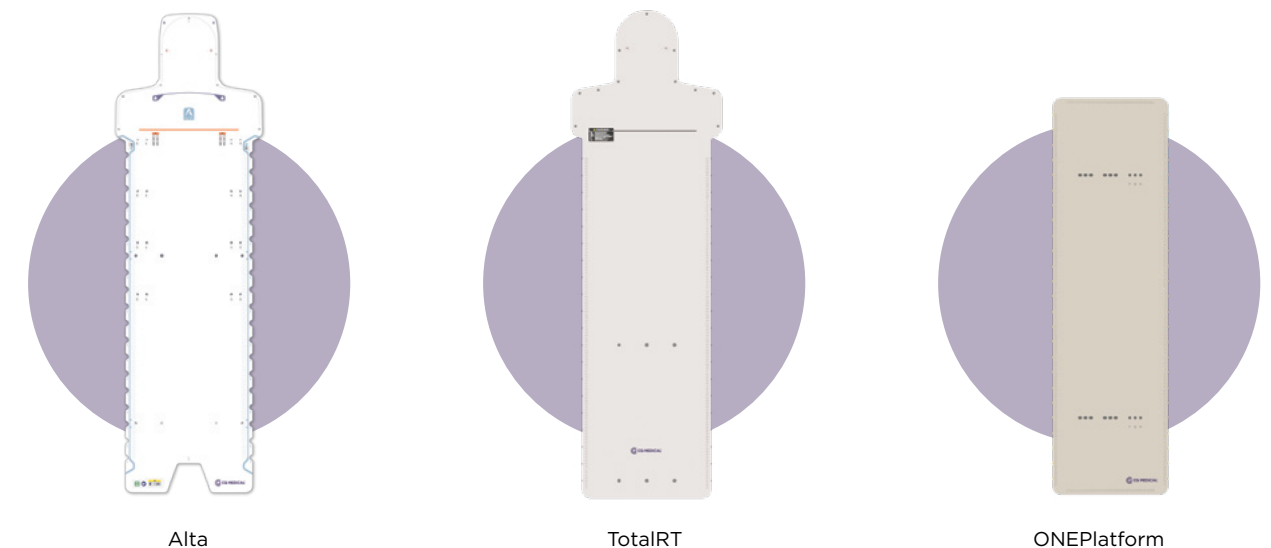

“ We have become a referral center for SBRT patients and have employed Body Pro-Lok system for several years. It is my opinion that reproducible immobilization and abdominal compression is vital to assist in accurate targeting of lung cancers and other localized tumors. We recently upgraded our Body Pro-Lok system to the new Body Pro-Lok ONE and added a second complete system. We find it to be more flexible and efficient, especially with larger patients, without sacrificing the precision I demand.

RONALD C. MCGARRY, M.D., PH. D. UNIVERSITY OF KENTUCKY, LEXINGTON, KENTUCKY

Alta Multipurpose Device

Alta is an all in one solution that quickly adapts positioning and immobilization solutions to your clinical setup and treatment needs, including hypofractionation.

- Features InfinityEdge™ profile and Varian Exact® Style indexing
- Combines functionality of multiple devices
- Can be extended beyond end of the couchtop for improved head and neck dosimetry
- Lightweight - 5.4 kg (12 lbs)
- CT, MR, and treatment compatible

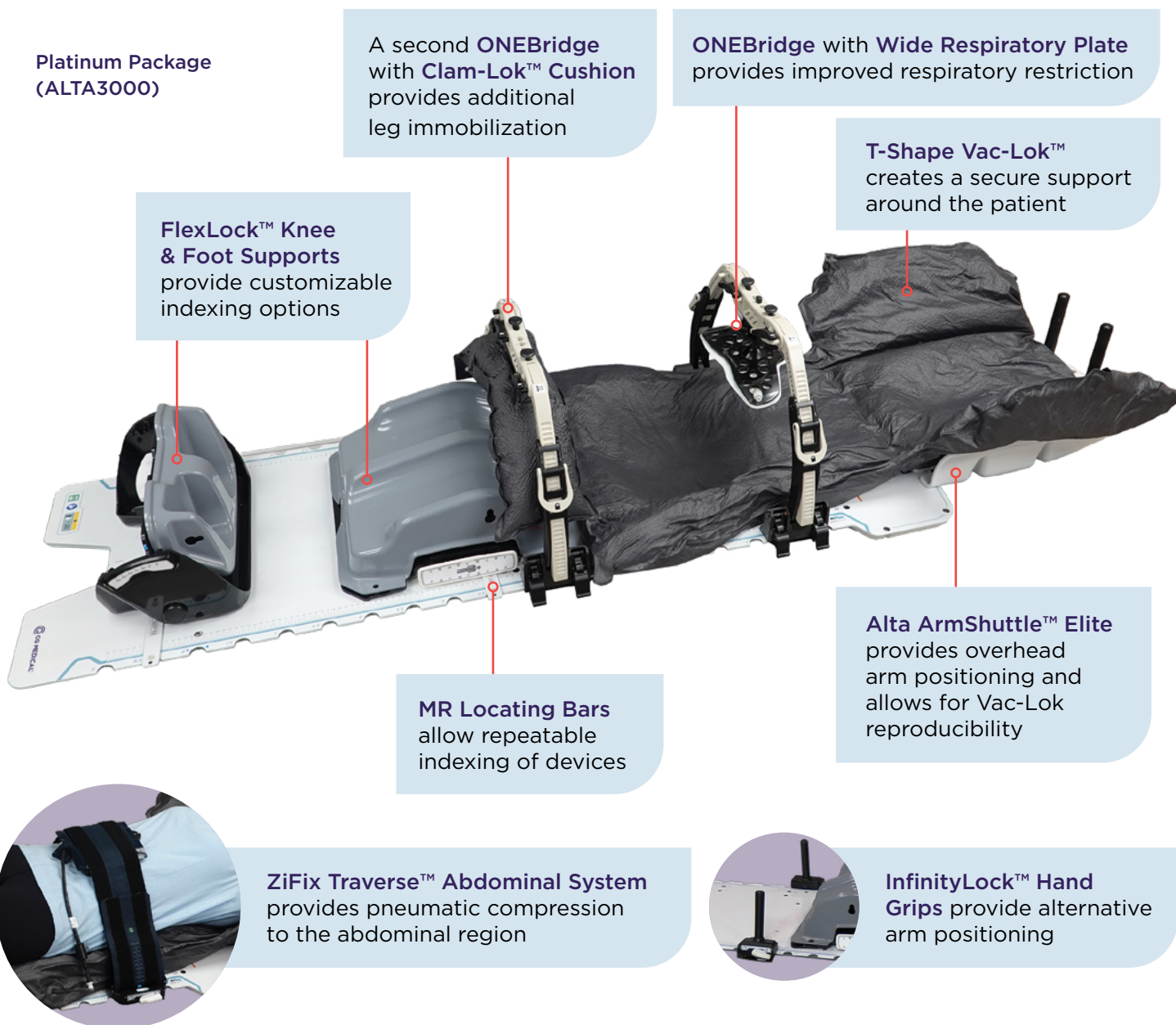

Package Includes:	Platinum Qty	Gold Qty	Silver Qty
 Alta Device	1	1	1
 MR Locating Bars	4	4	4
 Alta Silverman Adapter Plate	1	1	1
 ONEBridge	2	2	1
 ONEBridge Storage Base	2	2	1
 ZiFix Traverse Abdominal System	1	1	1
 Wide Respiratory Plate	1	1	1
 ComfortCare™ Cushions	3	3	3
 Hand Pump	1	1	1
 Clam-Lok Cushion	2	2	2
 Alta ArmShuttle Elite	1	1	1
 T-Shape Vac-Lok	5	-	-
 InfinityLock Hand Grip Set	1	-	-
 FlexLock Knee Support	1	1	-
 FlexLock Foot Support	1	1	-
 Kneefix™ Cushion	-	-	1
 Feetfix™ Cushion	-	-	1
 Wall Mount	1	-	-
	ALTA3000	ALTA2000	ALTA1000

TotalRT Platform

TotalRT is an all in one solution that quickly adapts positioning and immobilization solutions to your clinical setup and treatment needs, including hypofractionation.

- Features Universal Couchtop™ profile and Prodigy™ 2 indexing
- Large, artifact-free and homogeneous treatment area for precise dose delivery
- Combines functionality of multiple devices
- Can be extended beyond end of the couchtop for improved head and neck dosimetry
- Lightweight - 7.3 kg (16 lbs)
- CT, MR, and treatment compatible



Package Includes:	Platinum Qty	Gold Qty	Silver Qty
 	1	1	1
 	2	2	1
	1	1	1
 	1	1	1
	3	3	3
	1	1	1
	2	2	2
	1	-	-
	1	1	1
	5	-	-
 	1	-	-
 	1	1	-
	-	-	1
	1	-	-
	TRT3000	TRT2000	TRT1000

ONEPlatform™

ONEPlatform provides a simple platform solution for complex SBRT patient setups.

- Features Universal Couchtop profile and Prodigy 2 indexing
- Lightweight - 7.5 kg (16.5 lbs)
- CT, MR, and treatment compatible



Package Includes:	Platinum Qty	Gold Qty	Silver Qty
  ONEPlatform	1	1	1
  ONEBridge	4	4	4
 ONEBridge Storage Base	2	2	1
 ONE Respiratory Belt	1	1	1
  Wide Respiratory Plate	1	1	1
 ComfortCare Cushions	3	3	3
 Hand Pump	1	1	1
 Clam-Lok Cushion	2	2	2
 Monarch Overhead Arm Positioner	1	-	-
 T-Shape Vac-Lok	5	-	-
 Patient Handle Set	1	-	-
  FlexLock Knee Support	1	1	-
 FlexLock Foot Support	1	1	-
  Kneefix Cushion	-	-	1
 Feetfix Cushion	-	-	1
 Overlay Stand	1	-	-
	ONE3000	ONE2000	ONE1000

Body Pro-Lok ONE Couchtop Compatibility

Universal Couchtop

The Universal Couchtop is a modern and comprehensive solution for enabling advanced treatments in your clinic. Specifically designed to answer the demands of IGRT delivery, the Universal Couchtop Long Extension contains no rails or junctions in the treatment area to help facilitate better dose delivery and target coverage.

The Universal Couchtop is available for LINAC and CT, providing an environment in simulation that is reproducible and dosimetrically matched in treatment.



kVue™ One Couchtop Low-e™

The kVue One Couchtop is a one-piece modular design with a homogeneous composite base and no moving rails. It offers the ability to interchange treatment specific kVue inserts that mount directly into the top surface of the couch through the One Touch Latch. The light weight kVue One is compatible with versions of 6 Degrees of Freedom (DOF) linear accelerators and robotic bases.

kVue Couchtops are available for LINAC and CT providing an environment in simulation that is reproducible and provides for more accurate dose planning and delivery.

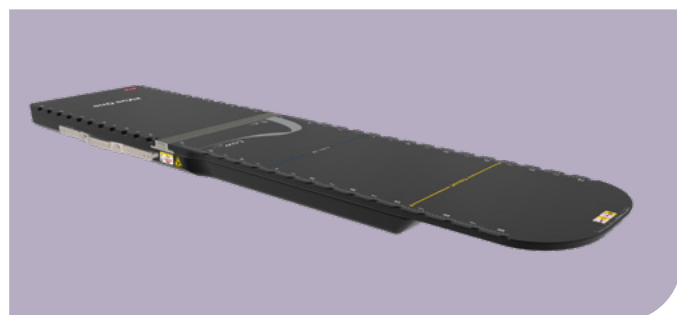

**DEVICE PACKAGES ARE AVAILABLE.
CONTACT YOUR SALES REP FOR DETAILS.**

Body Pro-Lok ONE Couchtop Compatibility

Elekta iBEAM® evo Couchtop

ONEBridge and ONE Respiratory Belt are compatible via a special adapter that allows for 1 cm indexing to iBEAM evo couchtops.

BPL010 Body Pro-Lok ONE evo Adapter, 1 Pair



ONEBridge w/ evo Adapter

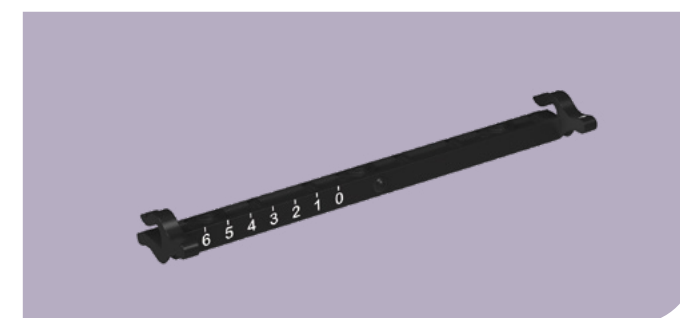

Rails-Only System

The Body Pro-Lok ONE Rails-Only System provides compatibility of the Body Pro-Lok ONEBridge and ONE Respiratory Belt on IGRT couchtops and CT overlays with Varian Exact indexing when avoidance of an overlay or platform is preferred. Bridges and accessories are sold separately.

BPL020 53 cm, Varian Exact



RESPIRATORY RESTRICTION PACKAGE

ONEBridge	Qty 1
ONEBridge Storage Base	1
ONE Respiratory Belt	1
Wide Respiratory Plate w/ ComfortCare Cushion (x3) and Hand Pump	1
BPL ONE Exact/IGRT Rails-Only	1
BPL300	

SBRT Device Customization

SBRT BRIDGE



ONEBridge

Unique design features allow for improved patient positioning and compression plate restriction.

See page 49 for more details.

BPL001	Attaches to Universal Couchtop profiles, including the TotalIRT Platform and ONEPlatform
RT-4800-B3	Attaches to InfinityEdge profiles, including the Alta Multipurpose Device & kVue Low-e Insert

BRIDGE ACCESSORIES



Wide Respiratory Plate with ComfortCare Cushion

Helps diffuse pressure across the abdominal region while adding a dimension of customized comfort for the patient.

BPL120	Start up Kit (Wide Plate, 3 Cushions and Hand Pump)
BPL007	ComfortCare Cushions, Qty 3
BPL008	Wide Respiratory Plate
BPL009	Hand Pump



Standard Respiratory Plate

Places pressure at the level of the diaphragm to assist in restricting respiratory movement.

MTSBRT003



Clam-Lok™ Cushion

Forms to comfortably enhance immobilization from above.

VLSBRT202FC

SBRT Device Customization

RESPIRATORY BELTS



ONE Respiratory Belt

Provides pneumatic compression and immobilization to the abdominal region.

BPL026



ZiFix Traverse™ Abdominal/Thoracic Motion Control System

ZiFix Traverse attaches to the edges of the Alta Multipurpose device to help immobilize the patient in addition to reducing organ motion.

- Low profile compression for most imaging and treatment systems
- Immobilizes patient during imaging and treatment
- Minimizes potential for collisions and interference when compared to compression bridge

COMING SOON! ONECLAMP ENABLING CROSS COMPATIBILITY OF ZIFIX TRAVERSE AND ONE RESPIRATORY BELT TO ALL ALTA, TOTALRT, AND ONEPLATFORM DEVICES

130 mm x 1700 mm Belt	Qty 1
130 mm x 1300 mm Belt	1
Manometer Pump	1
130 mm Compression Paddle w/ Inflatable Bladder	1
Clamps	2
RT-4558CB03	



Fiducial markers aid in consistent patient setup relative to patient anatomy

Bladder is designed to be durable up to 250 mmHg, a 2x factor of safety

Features InfinityLock to quickly and securely attach to compatible CQ Medical devices

SBRT Device Customization

VACUUM CUSHIONS



T-Shape Vac-Lok, 108 x 125 cm

Provides arms-up positioning while cradling the torso region. May be used with the Monarch Overhead Arm Positioner or a Wing Board.

VL0017	Nylon w/ indexing, Tapered mid-section, 44L Fill
VL0018	Nylon w/ indexing, Non-Tapered mid-section, 42L Fill
VL0022	Nylon w/ indexing, Tapered mid-section and Handle Cut Out, 31L Fill



VacQfix Cushions

Contoured positioning that custom forms to a specific patient for enhanced comfort and accuracy.

RT-4517-0002M	2-Chamber cushion, 120 cm tapered to 80 x 160 cm
RT-4517-0003M	3-Chamber cushion, 120 cm tapered to 80 x 230 cm

KNEE & FOOT SUPPORTS



FlexLock Knee & Foot Supports

Provides customizable indexing options for positioning the lower abdomen, pelvis, and lower extremities.

See page 152 for more information.

RT-4800-KS	FlexLock Knee Support
RT-4800-FS	FlexLock Foot Support



Kneefix 3 & Feetfix 3 Cushions

Contributes to better stability, reproducibility and comfort in the supine position.

301052	Kneefix 3
301071	Feetfix 3
301055	Elevation Block

SBRT Device Customization

WING BOARDS & HEADRESTS



ArmShuttle Elite

Provides many head & arm positioning options in a lightweight and ergonomic design.

RT-4546C	ArmShuttle Elite, 2-pin indexable
RT-4800-02	Alta ArmShuttle Elite



Pro Wing Board

The Pro Wing Board is 23.4" (59 cm) wide and features Individual Hand Grips that are easily adjustable 24 cm on a track in 2.2 cm increments for customized placement of each hand/arm. Four headrest options (Gel Head Rest, Round Head Cup, Posifix Headrests, and Timo Headrests) are indexable in multiple positions.

OAP220	Pro Wing Board with Pro Handles and Gel Head Rest. 2 or 3-pin indexable.
--------	--



Monarch Overhead Arm Positioner

Dual function hand grips allow for natural flexion of the patient's wrists while providing increased positioning options for the clinician.

OAP110	Monarch (includes M Handle, Tracks, and Headrest). 2 or 3-pin indexable.
--------	--



See page 144 for additional Wing Board options

SBRT Device Customization

HANDLES & LOK-BARS



Patient Handles

Patient handles provide a stable place for immobilized patients to place their hands on Universal Couchtop, TotalRT Platform or ONEPlatform.

MTIL662501	Right handle
MTIL662502	Left handle



Infinity Lock and Grip Set

Patient handles provide a stable place for immobilized patients to place their hands on the Alta Multipurpose Device.

RT-4800-04	Qty 2, Set of left and right handle
------------	-------------------------------------



MR Lok-Bar/Locating Bar

Allows positioning devices to be fixed to the couchtop or platform for enhanced reproducibility. See pages 190 - 198 for MRSeries.

RT-4551BARMRI	Varian Exact indexing, Two-Pin (left photo)
MTIL6054	Prodigy 2, 53 cm, Two-Pin (right photo)



Prodigy 2 Lok-Bar

Allows positioning devices to be indexed to the TotalRT Platform or Universal Couchtop.

MTIL6050	Prodigy 2, 53 cm, Two-Pin
----------	---------------------------



Transverse Lok-Bar

Allows the two-pin system to move laterally across the couchtop.

MTIL6051	Prodigy 2, 53 cm, Two-Pin
----------	---------------------------



Slide Guide Lok-Bar

Ideal for Vac-Lok bags, the Lok-Bar slides longitudinally along the couchtop rather than locking down to indexing points.

MTVL00853	Two-Pin
-----------	---------

Additional Compression Customization

BRIDGES & CUSHIONS



InfinityLock™ Bridges & Paddle

The InfinityLock Bridges attach to the edges of the Alta multipurpose device to help immobilize the patient and reduce organ motion.

RT-4800-B1	InfinityLock SBRT Compression Bridge, Small (min: 300 mm & max: 380 mm)
RT-4800-B2	InfinityLock SBRT Compression Bridge, Large (min: 390 mm & max: 480 mm)
RT-4558KV4	Compression Paddle, Standard
RT-4558KV4-01	Compression Paddle, Low Profile



Thigh Compression VacQfix Cushion

Complete leg immobilization with adjustable, snap-on attachment along InfinityLock compression bridge.

RT-4517-4079VF15M

kVue One Low-e Insert

The kVue Low-e insert is a low electron generating, homogeneous insert for enhanced imaging and treatment. It can be used in conjunction with the radiolucent kVue Compression Bridges for SBRT treatments, improving workflow efficiencies and eliminating the need for a separate SBRT device.

See page 63 for Low-e SBRT customization.

- Used for a wide range of patient treatment setup
- Low water equivalence

RT-4551KV19	kVue Low-e Insert, 1325 mm
RT-4558-B1	kVue SBRT Bridge, Small
RT-4558-B2	kVue SBRT Bridge, Large
RT-4558KV4	Compression Paddle, Standard
RT-4558KV4-01	Compression Paddle, Low-Profile



kVue Low-e Insert shown with kVue SBRT Bridges and Compression Paddle

kVue DoseMax Insert

Can be used with the radiolucent kVue Compression Bridges for stereotactic body radiotherapy (SBRT) treatments, improving workflow efficiencies and eliminating the need for a separate SBRT device.

See page 63 for DoseMax accessories.

- Lowest attenuating couchttop surface
- Maximizes dose to the tumor, while minimizing dose to the skin
- Ideal solution for a range of radiotherapy indications from palliative treatment to SBRT

RT-4551KV18	kVue DoseMax Insert
RT-4588-01	DoseMax Standalone Device for Simulation
RT-4558-B1	kVue SBRT Bridge, Small
RT-4558-B2	kVue SBRT Bridge, Large
RT-4558KV4	Compression Paddle, Standard
RT-4558KV4-01	Compression Paddle, Low-Profile



kVue DoseMax Insert shown with kVue SBRT Bridges and Compression Paddle

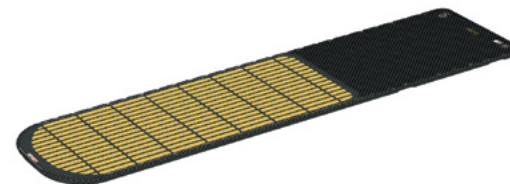

DoseMax Standalone Device for Simulation

CQ MEDICAL EDUCATION CENTER

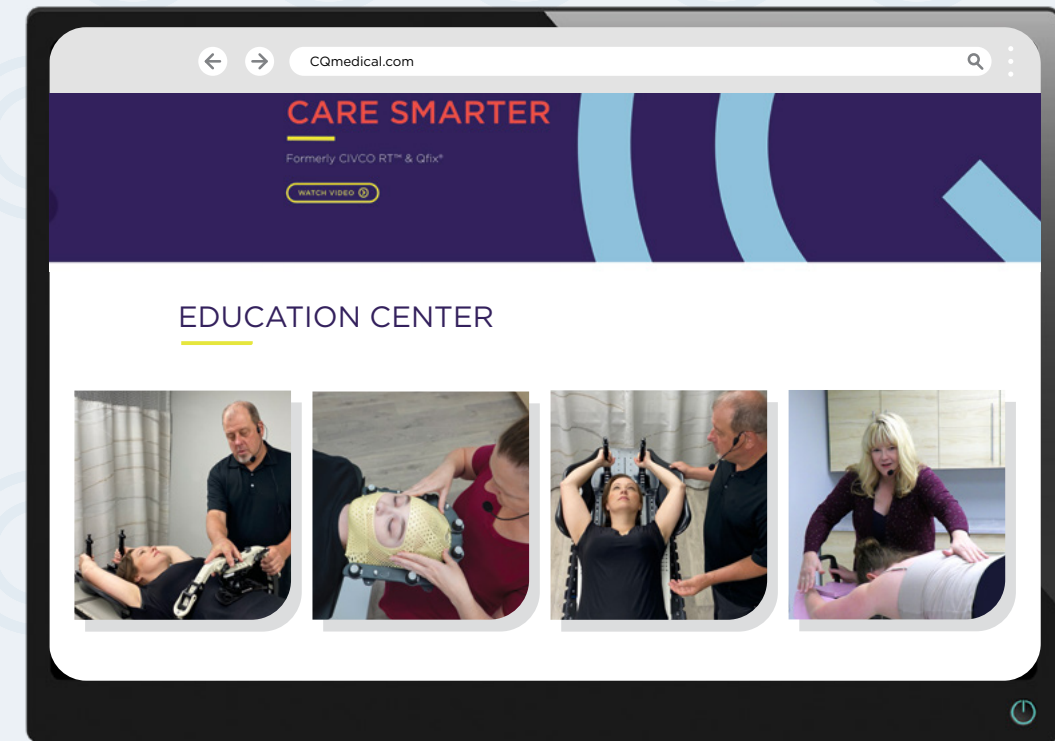

The CQ Medical Education Center is designed to **simulate a clinical environment** and **facilitate educational webinars**. The center allows us to provide **uninterrupted support** to our clinical partners around the world.

One of the greatest benefits of an interactive, web-based session is the ability to showcase our positioning & immobilization solutions and treatment options. It helps us understand your current workflow so that we can **focus on the device and techniques that work best for you**.

We are excited to offer a live learning resource to our customers & partners!



VIEW OUR CE WEBINAR OPPORTUNITIES OR SCHEDULE A TRAINING COURSE



COMFORTABLE IMMOBILIZATION IS NOT AN OXYMORON

Not to us, anyway. We believe that comfort and the products that hold a patient in place during radiotherapy must coexist. When a patient is immobilized and comfortable, it puts them in a better position for better possible outcomes.

 **CQ MEDICAL™**
Care Smarter

SRS/SRT (STEREOTACTIC RADIOSURGERY/ RADIOTHERAPY)



CHOOSING AN SRS IMMOBILIZATION SYSTEM



Encompass™ SRS Immobilization System

Solstice™ SRS Immobilization System

Pages 70-72

Pages 73-75

HYPERARC™ VALIDATED	Yes	No
SGRT COMPATIBLE	Yes	Yes
MR SAFE OPTION	Yes	Yes
THERMOPLASTIC OPTIONS	Open Face	Open or Closed Face
THERMOPLASTIC FRAME SIZE	1 (Standard)	2 (Standard or Narrow)
MASK ATTACHMENT STYLE	Integrated Shim Pins	Thermoplastic Clips
POSTERIOR HEAD SUPPORT	Thermoplastic or Customizable Cushion	Customizable Cushion
SHIM OPTION	Integrated in Frame, 0.5 mm increments	AccuForm Shim
BITE POSITIONER	IntegraBite	Precise Bite
SHOULDER THERMOPLASTIC	No	Yes
CORRECTIVE PITCH CAPABILITY	No	Yes
EMBEDDED FIDUCIAL	Yes	No

Encompass SRS Immobilization System

Highly rigid, non-invasive immobilization device designed for precisely targeted treatment to the brain, head & neck.

- Immobilization for treatment of multiple lesions with a single isocenter
- High-precision immobilization with submillimetric accuracy for stereotactic radiosurgery, including trigeminal neuralgia
- Integrated Shim System optimizes workflow efficiencies
- Open view thermoplastic can reduce patient anxiety and allows for intra-fraction positioning verification utilizing optical tracking systems
- Submillimetric immobilization with or without optional IntegraBite



Validated for HyperArc. Image is used courtesy from Varian, a Siemens Healthineers company.

Integrated Shim System

Innovative Integrated Shim allows independent height adjustment at each pin, providing completely customizable immobilization. Each Integrated Shim can be adjusted in discrete 0.5 mm increments, with a total range of 4 mm.

- Adjusting shim height is as easy as simply rotating the pin
- Eliminates the need for mask removal to adjust shim height
- Better workflow and instant setup feedback

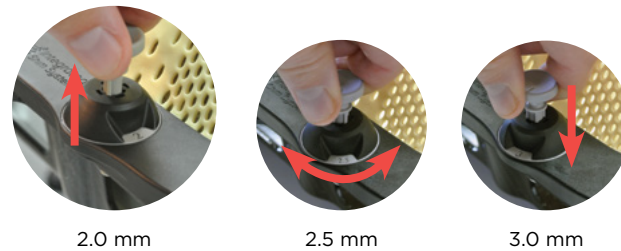

2.0 mm

2.5 mm

3.0 mm

IntegraBite

- Decreased head and neck rotation, flexion, and extension
- Repeatable positioning
- Simple, streamlined design makes application and insertion easy



Applicator

Biteplate

Encompass SRS Fibreplast Masks

Made from the most rigid thermoplastic material available, providing anterior and posterior cranial support.



Fibreplast Variable Perf Open View Mask

Posterior Thermoplastic

visionrt COMPATIBLE

Encompass SRS Devices

Encompass SRS Standalone Device

Device Length: 1358 mm
 Handling Weight: 5.5 kg (12 lb)
 Weight Limit: 249 kg (550 lb), Uniformly Distributed Load at maximum cantilever position indicated on device

RT-4600-01

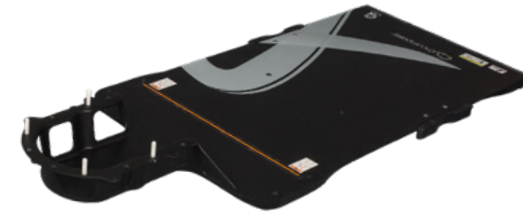

kVue Encompass SRS Insert

Device Length: 1311 mm
 Handling Weight: 4.5 kg (10 lb)
 Weight Limit: 249 kg (550 lb), Uniformly Distributed Load at maximum cantilever position indicated on device

RT-4600KV-01



Encompass SRS MR Standalone Device

Device Length: 1358 mm
 Handling Weight: 5.5 kg (12 lb)
 Weight Limit: 249 kg (550 lb), Uniformly Distributed Load at maximum cantilever position indicated on device

RT-4600-01-MRI



Encompass SRS Standalone Device compatible with bridges

Device Length: 1358 mm
 Handling Weight: 5 kg (11 lb)
 Weight Limit: 249 kg (550 lb), Uniformly Distributed Load at maximum cantilever position indicated on device

RT-4600-02



EO SRS Headrest and Hand Grip Array included with all Encompass Devices.

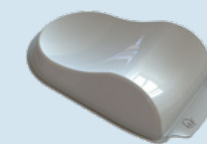

Direct Indexing Adapters are available for indexing the standalone device to specific couchtop models.



Encompass SRS Thermoplastic Options

Thermoplastic Option 1

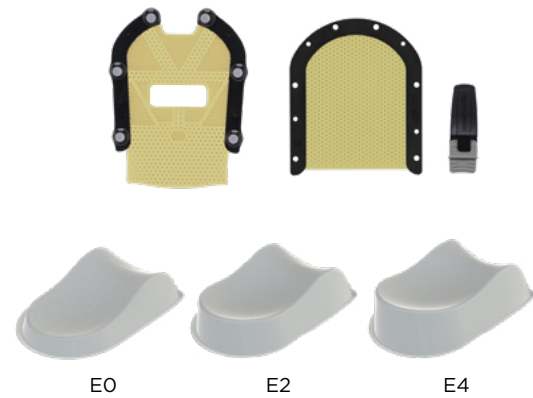

RT-B889KYCF2*	Encompass SRS Fibreplast System with Optional IntegraBite. Includes: Fibreplast Variable Perf Open View Mask, Posterior Thermoplastic, Optional IntegraBite See page 70 for more information
RT-4600-10*	E0 SRS Headrest (included with all Encompass devices)
RT-4600-12**	E2 SRS Headrest (included with SRS Adapter)
RT-4600-14**	E4 SRS Headrest (included with SRS Adapter)

Thermoplastic Option 2



RT-B889KYCF2A**	Encompass SRS Anterior Only Fibreplast Mask to be used with SRS Cushion Support (includes AccuForm U Head Cushion, 200 mm x 350 mm and optional IntegraBite)
RT-4600-20**	SRS Cushion Support (not included with Encompass or SRS Adapter)

*Validated with HyperArc
**Safe to use with HyperArc

Solstice SRS Immobilization System

The Solstice SRS Immobilization System provides unique corrective pitch capability and positioning flexibility for submillimeter accuracy to treat multiple lesions with a single isocenter. The system is comprised of a head support, customizable cushion and dedicated thermoplastic mask designed for secure and simple attachment. These components create a highly customizable and comfortable head and neck immobilization system for precise treatment to improve patient outcomes.

- Midline thermoplastic mask attachment provides increased rigidity and minimizes shrinkage to enhance patient comfort
- Highly conformal to the patient when using a customizable cushion and dedicated thermoplastic mask
- Unique thermoplastic frame provides easy to use, secure and quiet mask attachment
- Glass Fiber version is MR Safe

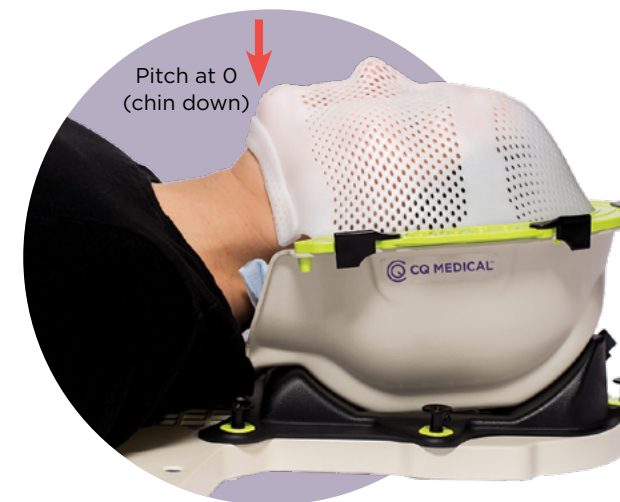
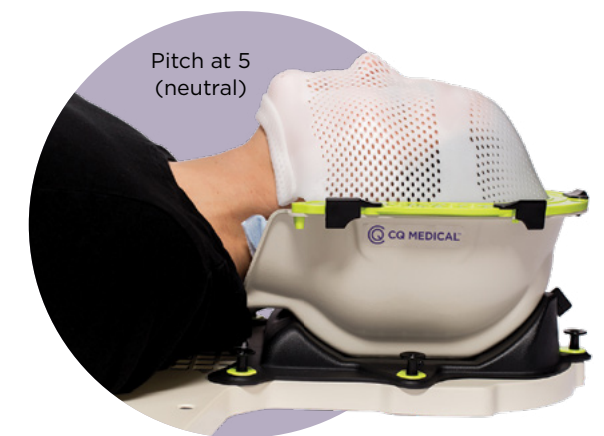
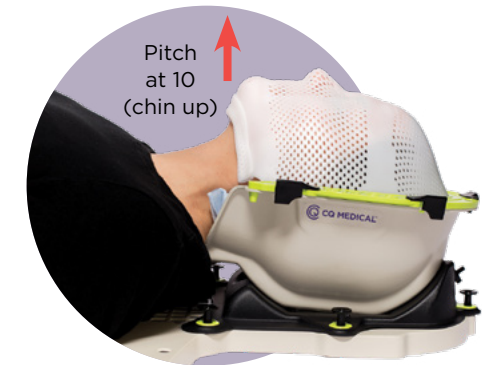

Variable pitch capability provides increased setup options in CT simulation, MR imaging (with glass fiber MR version) and corrective positioning flexibility during treatment setup.

Solstice SRS System Customization



Carbon Fiber with ClearVision Thermoplastic and Precise Bite

visionrt COMPATIBLE



Glass Fiber with IMRT Reinforced Thermoplastic

SGRT Starter Kit

Kit includes: Head Support, Solstice ClearVision Open-face Thermoplastic, Standard (x10), 20 x 35 cm Chamfered AccuForm Cushion (x10), Precise Bite (x5)

CHS03SGK	Carbon Fiber, Posifix
CHS04SGK	Carbon Fiber, Type-S
CHS03MRSGK	Glass Fiber MR, Posifix
CHS04MRSGK	Glass Fiber MR, Type-S

Standard Starter Kit

Kit includes: Head Support, Solstice IMRT Reinforced Thermoplastic Style 18, Standard (x10), 20 x 35 cm Chamfered AccuForm Cushion (x10), Precise Bite (x5)

CHS03K	Carbon Fiber, Posifix
CHS04K	Carbon Fiber, Type-S
CHS03MRK	Glass Fiber MR, Posifix
CHS04MRK	Glass Fiber MR, Type-S



Universal Couchtop
Type-S and Posifix Long Extensions allow for direct attachment of Solstice.
See page 12.



Alta and TotalRT All in One Solutions
Allow for direct attachment of Solstice.
See pages 43-45.

Individual Order Items



visionrt COMPATIBLE



Head Support

CHS03	Carbon Fiber, Posifix (left photo) Qty 1
CHS04	Carbon Fiber, Type-S, Qty 1
CHS03MR	Glass Fiber, MR, Posifix (right photo), Qty 1
CHS04MR	Glass Fiber, MR, Type-S, Qty 1

ClearVision Thermoplastic

MTAPCID1832SG	Standard (left photo), Qty 5
MTAPCIN1832SG	Narrow (right photo), Qty 5

IMRT Reinforced Thermoplastic Style 18

MTAPCID1832	Standard (left photo), Qty 5
MTAPCIN1832	Narrow (right photo), Qty 5

Shoulder Thermoplastic

MTAPSSTS	Type-S, Aquaplast RT, Solid (left photo), Qty 5
MTAPSSPF	Posifix, Aquaplast RT, Solid (right photo), Qty 5

AccuForm Cushions

MTACL2035	20 x 35 cm Chamfered, Qty 1
MTACL2035HF	20 x 35 cm Chamfered, Half Fill, Qty 1

Precise Bite

See page 116 for additional Precise Bite options.

MTCBPBITE	Standard, Qty 5
MTCBPBITES	Small, Qty 5

See Vision RT's compatibility statement on back cover.

SRS Adapter for Portrait & Type-S Devices

FLEXIBILITY TO PERFORM SRS TREATMENTS WITH PORTRAIT & TYPE-S DEVICES

Non-invasive solution that enables submillimetric positioning for stereotactic radiosurgery treatments on the Portrait Intracranial Head & Neck Devices and other Type-S devices. The system reduces motion, allowing for maximum dose to the tumor while minimizing radiation delivered to the surrounding healthy tissue.

- Enables single isocenter SRS treatment for multiple lesions when used in conjunction with Encompass SRS Fibreplast Masks
- Accommodates a variety of SRS headrests and cushion supports for a fully customizable setup
- Easy to set up and can help to minimize procedure time and cost

*RT-4600-03	SRS Adapter (includes headrests)
*RT-4600-03-MRI	MR SRS Adapter (includes headrests)

*Not validated for HyperArc

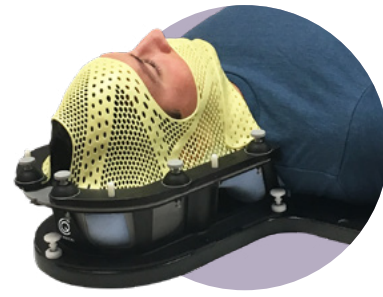

SRS Adapter shown on Portrait with SRS Cushion Support and AccuForm

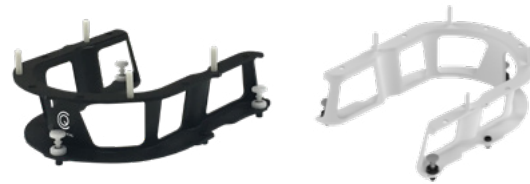

SRS Adapter

MR SRS Adapter

Encompass SRS Adapter Thermoplastic Options

Thermoplastic Option 1

Available in different heights for positioning patients in a comfortable, neutral head and neck position. They support the patient's head while forming the Encompass SRS Fibreplast Mask for simulation.

RT-4600-10	E0 SRS Headrest (included with SRS Adapter)
RT-4600-12	E2 SRS Headrest (included with SRS Adapter)
RT-4600-14	E4 SRS Headrest (included with SRS Adapter)
RT-B889KYCF2	Encompass SRS Fibreplast System with Optional IntegraBite See page 70 for more information

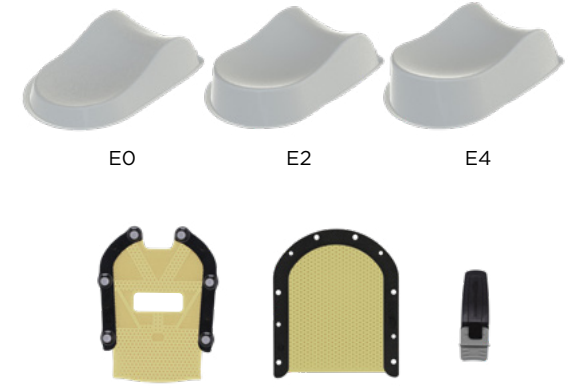

Thermoplastic Option 2

Compatible with AccuForm and an anterior Encompass SRS Fibreplast Mask.

RT-4600-20	SRS Cushion Support (not included with Encompass or SRS Adapter)
RT-B889KYCF2A	Encompass SRS Anterior Only Fibreplast Mask to be used with SRS Cushion Support (includes AccuForm U Head Cushion, 200 mm x 350 mm and optional IntegraBite)



AN OPEN LETTER TO FEAR

Dear Fear,

There is no place for you here.
No reason for being.
We know the anxiety you bring.
And we loathe it.
So, we took you on.
Designing rigid radiation immobilization masks
that allow a patient to see and breathe and feel as
physically and mentally comfortable as possible.
Because when patients are put more at ease,
they're in a better position for better outcomes.
You can't outrun us.
We see you.
Take that, fear.

 **CQ MEDICAL™**
Care Smarter



Head & Neck and Thermoplastics



87-98

TYPE-S DEVICES & THERMOPLASTICS

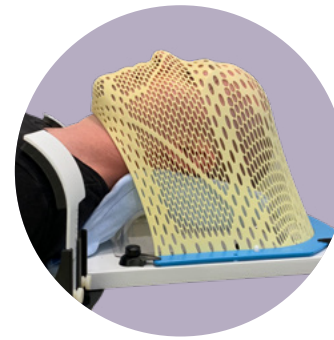

99-103

UNI-FRAME DEVICES & THERMOPLASTICS



104-108

POSIFIX DEVICES & THERMOPLASTICS



110-111

PEDIATRIC PROFORM DEVICES & THERMOPLASTICS



112

SOLSTAT IMMOBILIZATION SYSTEM



113, 116

BITE POSITIONERS & GRAYDUCK DART ORAL POSITIONING STENT

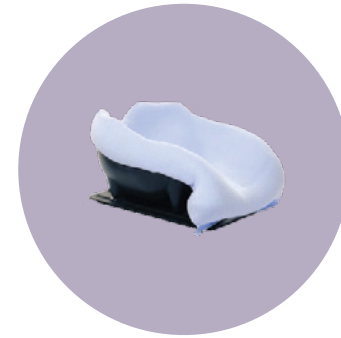

114

CUSTOMIZABLE HEAD SUPPORT



115

ACCUFORM CUSHIONS

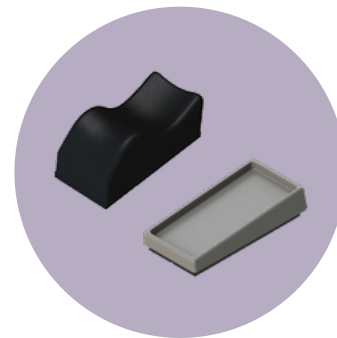

117-120

HEADRESTS, SPACERS & WEDGES



121

ADAPTERS



122-123

RAPIDHEAT OVEN & WATER BATH

CHOOSING A HEAD & NECK POSITIONING SYSTEM



Type-S™

The Type-S system was designed for IMRT and conformal treatments and is intended to provide minimal attenuation throughout 360° of treatment angles. Type-S thermoplastic masks offer the greatest variety of reinforced patterns, materials and frame type.

Pages 87-98

Uni-frame®

The Uni-frame system has become an industry standard solution for Head Only thermoplastic masks. They are available in a variety of standard and reinforced patterns, including Tranquility Series masks and the highly conformal ZENTEC material.

Pages 99-103

COMPATIBILITY	CT, MR, Photon	CT, MR, Photon
THERMOPLASTIC MATERIAL	Fibreplast, Aquaplast RT, ZENTEC	Fibreplast, Aquaplast RT, ZENTEC
SPECIAL FEATURES	<ul style="list-style-type: none"> • Integrated Shim • Pre-cut eye and mouth • Open-face, surface tracking • Variable Perf and reinforced patterns • Larynx extension • Neck relief • Pediatric option 	<ul style="list-style-type: none"> • Pre-cut eye and mouth • Open-face, surface tracking • Variable Perf and reinforced patterns
FRAME	<ul style="list-style-type: none"> • Continuous • Split 	<ul style="list-style-type: none"> • Continuous • Split



Posifix®

Posicast® thermoplastic masks were specifically formulated for use with the Posifix Patient Positioning System. They are drape-style which requires less stretching, therefore, resulting in less shrinkage. Drape-style masks allow for closer attachment of the mask to the patient.

Pages 104-108

Pediatric ProForm™

The ProForm Head & Neck system was developed for proton therapy, but offers additional use to treat pediatric patients undergoing conventional photon radiotherapy. ProForm accepts a dedicated thermoplastic mask, available in many reinforced patterns and design styles. Masks are sold in boxes of five and are disposable.

Pages 110-111

COMPATIBILITY	CT, MR, Photon	CT, MR, Photon, Proton
THERMOPLASTIC MATERIAL	Posicast, Fibreplast, Aquaplast RT	Aquaplast RT
SPECIAL FEATURES	<ul style="list-style-type: none"> • Open-face • Larynx extension • Smooth coating • Pediatric option 	<ul style="list-style-type: none"> • Pre-cut eye and mouth • Open-face, surface tracking • Reinforced patterns • Pediatric option
FRAME	<ul style="list-style-type: none"> • Drape 	<ul style="list-style-type: none"> • Continuous (Head Only) • Continuous to Drape (Head, Neck & Shoulders)



THERMOPLASTIC MATERIALS

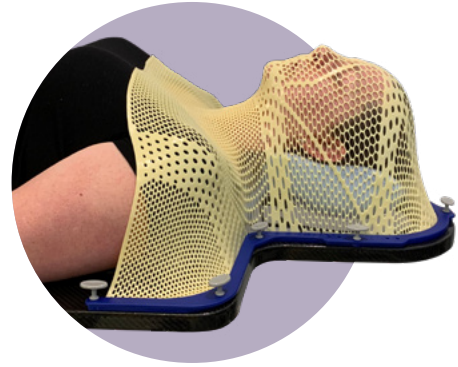

FIBREPLAST®

Fibreplast, our premium propriety thermoplastic, is more rigid than standard thermoplastics and shrinks less. Fibreplast is available in Micro Perforation (2.4 and 3.2 mm thickness), Standard Perforation (2.4 and 3.2 mm thickness), and Variable Perforation (2.4 and 3.2 mm thickness), which maximizes rigidity while minimizing the bolus effect.

- Water Bath and Dry Heat Oven compatible

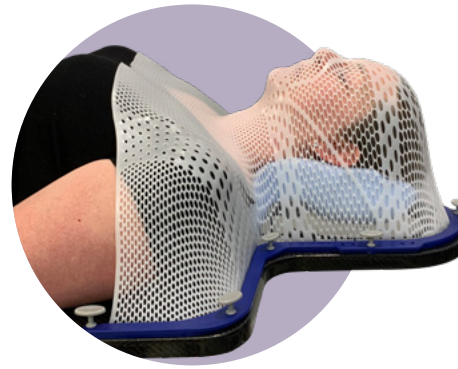

AQUAPLAST RT™

We are the inventors of Aquaplast RT. Its rigidity, resistance to shrinkage, and easy molding qualities are unparalleled in the industry. Aquaplast RT is available in Micro Perforation (2.4 and 3.2 mm thickness), Standard Perforation (2.4, 3.2 and 4.8 mm thickness), and Variable Perforation (2.4 and 3.2 mm thickness), which maximizes rigidity while minimizing the bolus effect.

- Water Bath and Dry Heat Oven compatible



ZENTEC™

ZENTEC requires less heating time than Aquaplast RT thermoplastics and has an established reputation of being highly conforming masks. The 2.4 mm thickness masks provide a lighter feeling, which offers a more pleasant experience for anxious patients. The 3.2 mm thickness offers a similarly conforming mask.

- Water Bath compatible



POSICAST®-LITE & POSICAST-PLUS

Posicast-Lite feels like a traditional thermoplastic with a smooth spray coating on both sides of the mask. They have a drape-style design that requires less stretching which results in minimal shrinkage during cooling.

Posicast-Plus has a soft polyurethane coating on the patient-contacting side for comfort, while the other side features a smooth spray coating to facilitate marking treatment fields on the mask. It is a drape-style design that requires less stretching which results in minimal shrinkage during cooling.

- Water Bath and Dry Heat Oven compatible

THERMOPLASTIC SPECIAL FEATURES



FREEDOMVIEW™ & OPEN EYE OPEN MOUTH

Eye openings help reduce fear while capturing bridge of nose. Mouth opening allows for tongue displacement and free breathing.

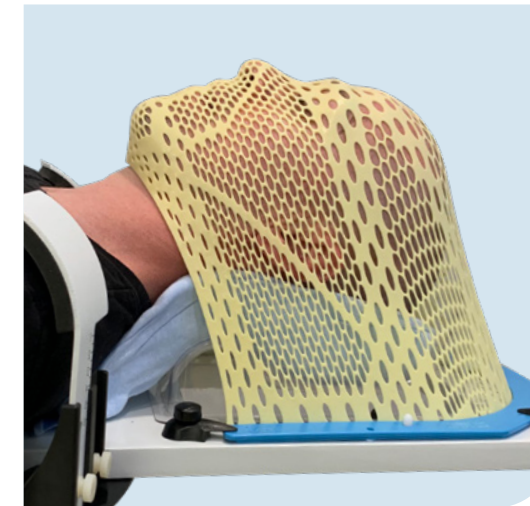
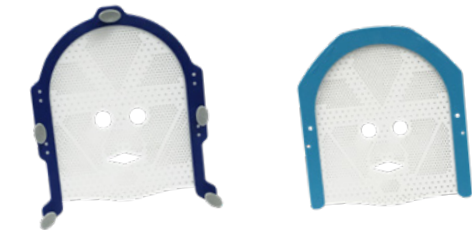

IMRT REINFORCED™ & VARIABLE PERF™ PATTERNS

Features a combination of standard perforated and solid/micro perforation thermoplastic in the mask design to provide rigidity and secure immobilization for treatment. By providing solid/micro perforated bands in areas where a secure hold is essential while maintaining standard perforation elsewhere, these masks provide a balance of immobilization and comfort.

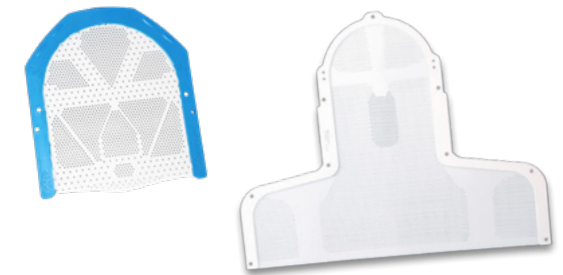

CLEARVISION™ 2 & ASSURE OPEN VIEW

Reduces patient fear while allowing real time patient monitoring using optical tracking systems.

visionrt | COMPATIBLE

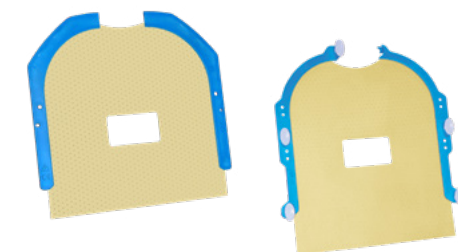

THERMOPLASTIC FRAME STYLES



INTEGRATED SHIM

The innovative Integrated Shim allows independent height adjustment at each pin, providing completely customizable immobilization. Each Integrated Shim can be adjusted in discrete 0.5 mm increments, with a total range of 4 mm.

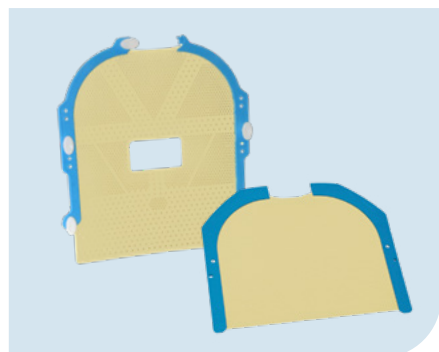

SPLIT-FRAMES

Split-frames reduce the stretching required of the thermoplastic, thus forming a more rigid mask. These masks also accommodate patients with long hair.



HEAD ONLY

Head Only masks are perfect for everything from whole brain to complex IMRT treatments.

The Uni-frame traditional frames are especially useful for patients with smaller heads. The Uni-frame Slimline frames are useful for patients with larger heads.

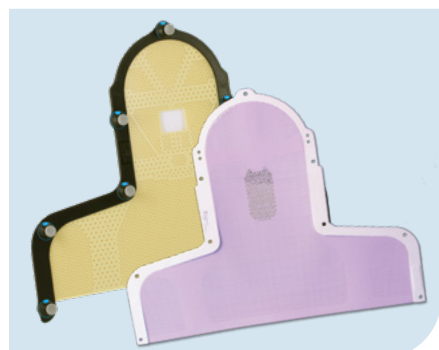

HEAD, NECK & SHOULDERS

Head, Neck & Shoulders masks extend below the patient's shoulders, providing additional immobilization.

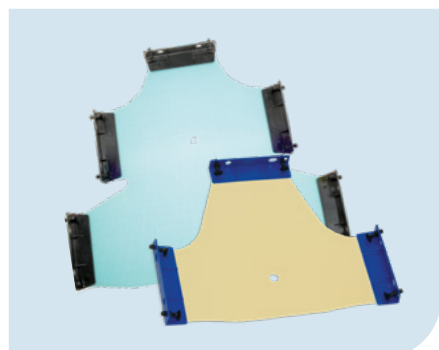

DRAPE STYLE

Posifix 3-point (head and neck) and 5-point (head & shoulders) disposable, drape-style requires less stretching, therefore, resulting in less shrinkage. Drape-style masks allow for closer attachment of the mask to the patient.

Type-S Extensions

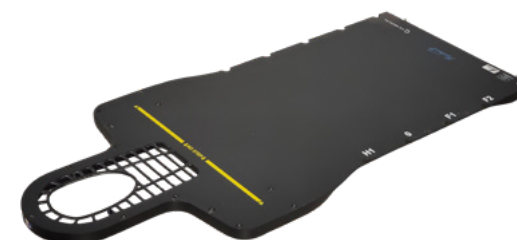
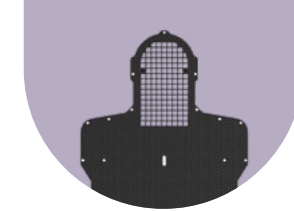

kVue Portrait Intracranial, Head & Neck Insert

Portrait devices and masks provide a high level of stability by limiting patient motion and reducing the probability of positioning errors.

The Portrait Insert can be extended beyond the end of the couchtop making it ideal for full 360° treatments.

Portrait accommodates supine and prone setups for patient specific treatments. Portrait is rigid while providing minimal attenuation.

RT-4552KV kVue Portrait Insert



Universal Couchtop Long Extension

The Universal Couchtop Long Extension self-locks onto the Universal Couchtop, allowing the thermoplastic to connect to the couchtop.

See pages 10-13 for more details.

MTIL6665 Length: 39.1" (99.3 cm)

MTIL6670 Length: 49.1" (124.7 cm)

MTIL6664 Length: 53.1" (134.9 cm)

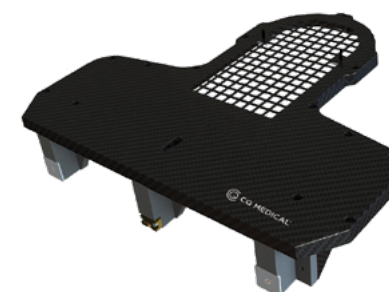

Varian Style Extension

The Varian Style Extension hooks easily on the superior end of a Varian style endplate. An optional reloadable head, neck & shoulder frame for Type-S thermoplastics is available.

MTCFHNV

Type-S Platforms

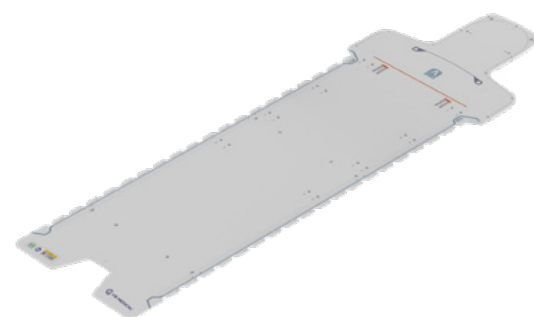

Alta Multipurpose Device

Alta can extend beyond the couchtop to provide improved access to the head and neck region. The Alta Multipurpose Device is compatible with Type-S thermoplastic masks, which can be directly attached to the device. A Silverman Adapter Plate enables the use of Silverman headrests to support the cervical spine during simulation and treatment. This setup provides high-precision positioning and reproducibility for head and neck applications.

See pages 41-43 for more details.

TotalRT All in One Platform

The TotalRT All in One Platform is designed to quickly adapt many positioning and immobilization solutions to your clinical setup and treatment needs, including head and neck.

See pages 44-45 for more details.

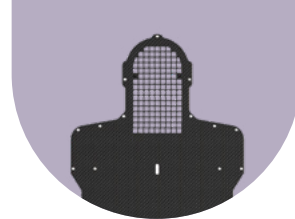

Type-S Baseplates



Variable Axis Baseplate with Prone Face Cushion (sold separately)



Patient Setup with Variable Axis Baseplate and Prone Face Cushion



Variable Axis Baseplate with optional Adapter and Prone Headrest

Variable Axis Baseplate

The Variable Axis Baseplate integrates with any Type-S extension or overlay to provide a tilting movement with patient fixation in either prone or supine positions. The unique variable axis design allows for natural head and neck movement and features a rotating knob to lock the baseplate into an angle position from 0°-30° in supine position and 12.5°-32.5° in prone position. The baseplate accommodates Type-S head only thermoplastics and accepts the Prone Face Cushion or the Posifix Prone Headrest via an adapter and shim.

See pages 117-119 for supine headrest options.

See page 99 for TiltPro Tilting Base.

MTCFHNAB01	Variable Axis Baseplate
MTPFC02	Prone Face Cushion
301025BLK	Posifix Prone Headrest
301035	MR Posi-S Adapter (see page 121)
MTSHIMT	Timo Shim (must be used with 301035)

Type-S Overlays



Portrait Intracranial, Head & Neck Device

The Portrait device offers superior immobilization for brain and head & neck radiotherapy. It is easy to use and lightweight for daily reproducibility.

- Indexes to the couchtop with either a two-pin Locating Bar or a Direct Indexing Adapter (see page 121)
- Utilizes Type-S thermoplastics for high stability and reduced positioning errors
- Can extend beyond couchtop for 360° treatments
- Suitable for both supine and prone setups, providing minimal attenuation while remaining rigid

RT-4552	Portrait Intracranial, Head & Neck Device
RT-4552MRI	Portrait MR Intracranial, Head & Neck Device compatible with bridges
RT-4525HGA	Hand Grips, pair (sold separately)

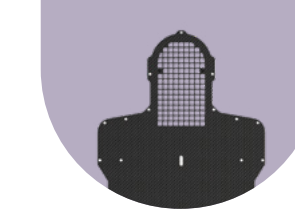

Type-S Overlays

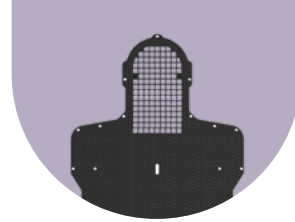

iBEAM® Overlay Adapter

Created for the Medical Intelligence iBEAM and iBEAM EVO couchtops. The overlay is cantilevered, providing minimal attenuation in the area of treatment.

108073

Overlay Board

Extends off the end of the treatment couch. An optional reloadable head, neck and shoulders frame for Type-S thermoplastics is available.



20CFHNSUB7	Overlay (no Vac-Lok indexing hole for larger unobstructed treatment region)
20CFHNSUB2	Overlay (with Vac-Lok indexing hole)
20CFHNSUB1P	ABS Reloadable Type-S Frame Only

MRI Type-S Overlay

Made of fiberglass with a foam core for use in MR environments. The MRI Overlay is lightweight and three-pin indexable.



MTMRHNTYPES	(left photo)
MTMRHNPN	Narrow (right photo)

Fixator™ Shoulder Supression System

The Fixator Shoulder Supression System is designed to enhance the benefits of the Type-S system. The Fixator extends off the couchtop and includes adjustable padded positioners to gently cup the patient's shoulders, capturing and positioning them out of the treatment field. Indexed nomenclature allows for easily recorded shoulder repositioning. Type-S Head Only IMRT Reinforced Thermoplastic masks are recommended for use with this system.



MTCFHN006	Fixator with Shoulder Cups (x2)
MTCFHN006SUB6	Shoulder Cup, Qty 1

Portrait™ with Integrated Shim™

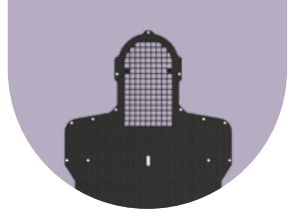

The innovative Integrated Shim allows independent height adjustment at each pin, providing completely customizable immobilization. Each Integrated Shim can be adjusted in discrete 0.5 mm increments, with a total range of 4 mm.

- Independent shimming at each pin point
- No need to remove mask to tighten or loosen
- Increased workflow efficiencies
- Increased patient comfort
- Better workflow and instant setup feedback



TO ADJUST SHIM HEIGHT

- Pull up to unlock
- Rotate to the desired height adjustment
- Depress to lock

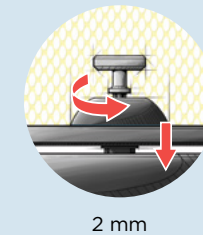

2 mm



0 mm

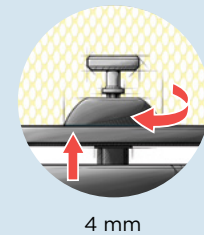

4 mm

See Fibreplast & Aquaplast RT with Integrated Shim Thermoplastic on Page 92

Type-S Thermoplastics

Masks on this page are disposable and sold in Qty 1. Must purchase in multiples of 5.

Fibreplast & Aquaplast RT with Integrated Shim

VARIABLE PERF

RT-A889KYSD	Fibreplast, Head Only, 3.2 mm
RT-A892KYSD	Fibreplast, Head & Shoulder, 3.2 mm
RT-A892YSD	Aquaplast RT, Head & Shoulder, 3.2 mm

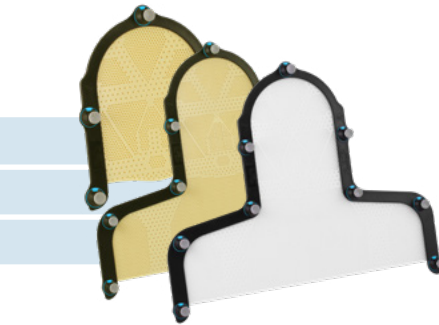

STANDARD PERF

RT-A782KSD	Fibreplast, Head & Shoulder, 2.4 mm
------------	-------------------------------------



ASSURE OPEN VIEW, MICRO PERF

RT-A876KSDGLF	Fibreplast, Head Only, Split frame, 3.2 mm
---------------	--



visiφnrt | COMPATIBLE

ASSURE OPEN VIEW, VARIABLE PERF

RT-A892KYSDF	Fibreplast, Head & Shoulder, 3.2 mm
--------------	-------------------------------------



visiφnrt | COMPATIBLE



Fibreplast Variable Perf



Assure Open View with Variable Perf



Aquaplast RT Variable Perf

Type-S Thermoplastics

Masks on this page are disposable and sold in Qty 1. Must purchase in multiples of 10.

Fibreplast & Aquaplast RT Head Only

VARIABLE PERF

RT-1889KYSD	Fibreplast, 3.2 mm
RT-1889YSD	Aquaplast RT, 3.2 mm
RT-1889YSDR	Aquaplast RT, Open Eye & Mouth, 3.2 mm



STANDARD PERF

RT-1779KSD	Fibreplast, 2.4 mm
RT-1889KSD	Fibreplast, 3.2 mm
RT-1779SD	Aquaplast RT, 2.4 mm
RT-1889SD	Aquaplast RT, 3.2 mm

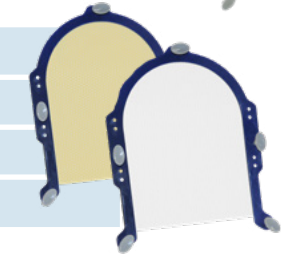

STANDARD PERF, LONG

RT-1889KSDL	Fibreplast, 3.2 mm
RT-1779SDL	Aquaplast RT, 2.4 mm
RT-1889SDL	Aquaplast RT, 3.2 mm

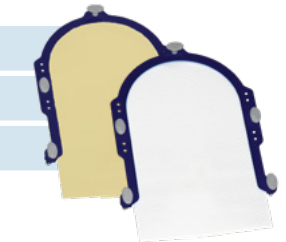

Fibreplast & Aquaplast RT Split-frames

VARIABLE PERF

RT-1776KYSDGXF	Fibreplast, Head Only, Extended, Assure Open View, 2.4 mm
RT-1876KYSDGLF	Fibreplast, Head Only, Long, Assure Open View, 3.2 mm

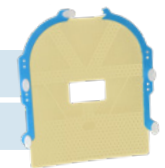

visiφnrt | COMPATIBLE

MICRO PERF

RT-1776KSDGXF	Fibreplast, Head Only, Extended, Assure Open View, 2.4 mm
RT-1876KSDGLF	Fibreplast, Head Only, Long, Assure Open View, 3.2 mm

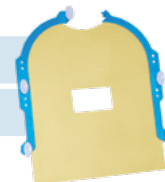

visiφnrt | COMPATIBLE

STANDARD PERF

RT-1889KSD-S3	Fibreplast, Head Only, 3.2 mm
RT-1889SD-S3	Aquaplast RT, Head Only, 3.2 mm



See Vision RT's compatibility statement on back cover.

Type-S Thermoplastics

Masks on this page are disposable and sold in Qty 1. Must purchase in multiples of 10.

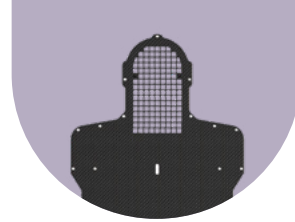

Fibreplast & Aquaplast RT, Head, Neck & Shoulders

VARIABLE PERF

RT-1782KYSDF	Fibreplast, Assure Open View, 2.4 mm
RT-1892KYSDF	Fibreplast, Assure Open View, 3.2 mm
RT-1892KYS	Fibreplast, 3.2 mm
RT-1892YSD	Aquaplast RT, 3.2 mm
RT-1892YSDR	Aquaplast RT, Open Eye & Mouth, 3.2 mm

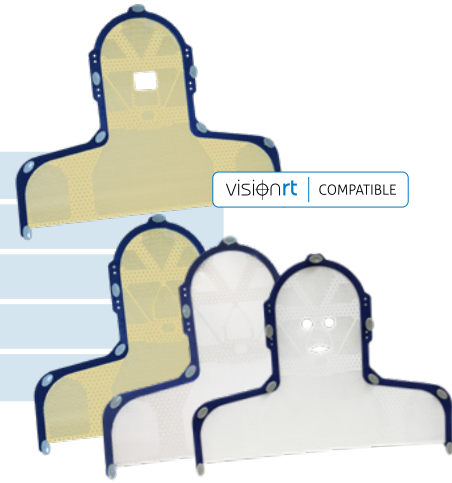

visionrt | COMPATIBLE

MICRO PERF, ASSURE OPEN VIEW

RT-1778KSDF	Fibreplast, 2.4 mm
RT-1878KSDF	Fibreplast, 3.2 mm

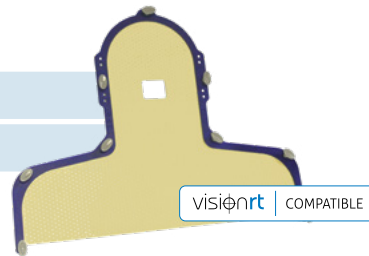

visionrt | COMPATIBLE

STANDARD PERF

RT-1782KSD	Fibreplast, 2.4 mm
RT-1892KSD	Fibreplast, 3.2 mm
RT-1782SD	Aquaplast RT, 2.4 mm
RT-1892SD	Aquaplast RT, 3.2 mm

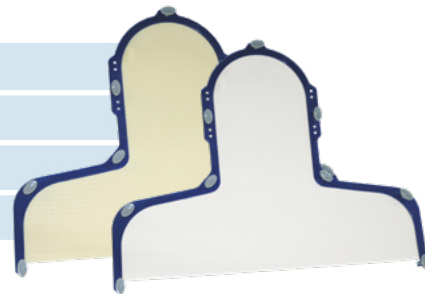

Type-S Thermoplastics

Masks on this page are disposable and sold in Qty 5.

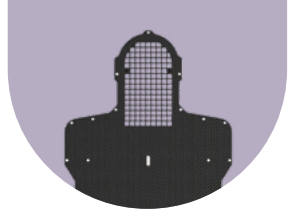

Aquaplast RT, FreedomView

MTAPUID1832CL	Head Only, IMRT Reinforced Style 18, 3.2 mm
MTAPUID1832CLRD	Head Only, IMRT Reinforced Style 18, Radius 13", 3.2 mm
MTAPSID27NR32CL	Head, Neck & Shoulders w/ Neck Relief, IMRT Reinforced Style 27, 3.2 mm

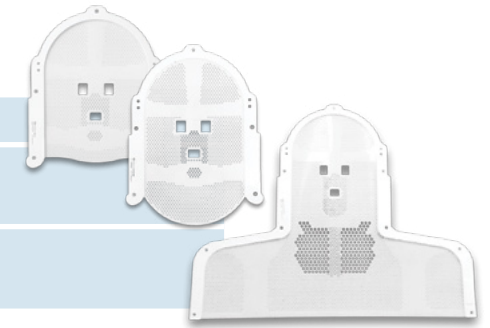

Aquaplast RT, Shoulder Thermoplastic

MTAPSSTS	Solid, 3.2 mm
----------	---------------

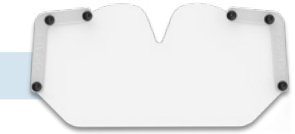

Aquaplast RT, ClearVision 2

MTAPUID1832SG	Head Only, 3.2 mm
MTAPSID2732SG	Head, Neck & Shoulders, 3.2 mm

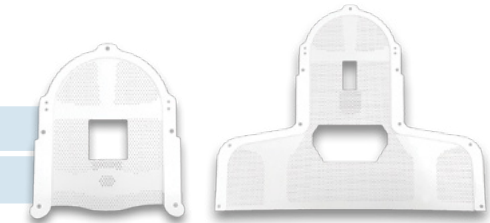

Aquaplast RT, ClearVision

MTVRT20	Head Only, 3.2 mm
---------	-------------------

See Vision RT's compatibility statement on back cover.



visionrt | COMPATIBLE



FreedomView Head Only



FreedomView Head, Neck & Shoulders



Shoulder Thermoplastic



ClearVision 2 Head, Neck & Shoulders

Type-S Thermoplastics

Masks on this page are disposable and sold in Qty 5.

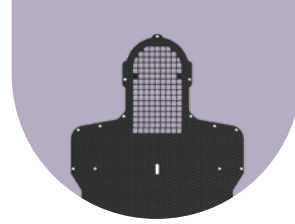

ZENTEC, IMRT Reinforced

MTAPUID1824VT	Head Only, Style 18, 2.4 mm
MTAPUID1832VT	Head Only, Style 18, 3.2 mm
MTAPSID2724VT	Head, Neck & Shoulders, Style 27, 2.4 mm
MTAPSID2732VT	Head, Neck & Shoulders, Style 27, 3.2 mm

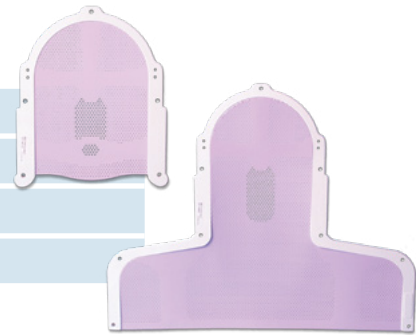

For added customizable hold, see page 98 for Reinforcement Thermoplastic Strips.

Aquaplast RT, IMRT Reinforced

MTAPUID1824	Head Only, Style 18, 2.4 mm
MTAPUID1832	Head Only, Style 18, 3.2 mm
MTAPUID181332RD	Head Only with 13" Radius Bottom, Style 18, 3.2 mm
MTAPSID2724	Head, Neck & Shoulders, 2.4 mm
MTAPSID2732	Head, Neck & Shoulders, 3.2 mm
MTAPSID27NR24	Head, Neck & Shoulders with Neck Relief, Style 27, 2.4 mm
MTAPSID27NR32	Head, Neck & Shoulders with Neck Relief, Style 27, 3.2 mm

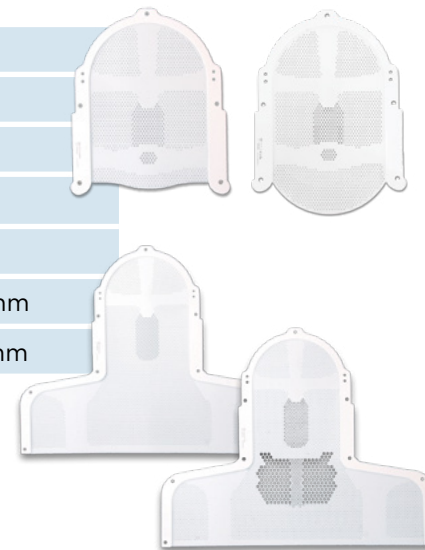

ZENTEC
IMRT Reinforced
Style 27



Aquaplast RT IMRT
Reinforced Style 18



Aquaplast RT Style 18
Radius Bottom



Aquaplast RT IMRT
Reinforced Style 27

Type-S Thermoplastics

Masks on this page are disposable (unless otherwise noted) and sold in Qty 5.

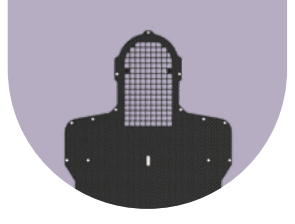

Aquaplast RT, Standard Perforation

MTAPUD2.4	Head Only, 2.4 mm
MTAPUD	Head Only, 3.2 mm
MTAPSD2.4	Head, Neck & Shoulders, 2.4 mm
MTAPSD3.2	Head, Neck & Shoulders, 3.2 mm

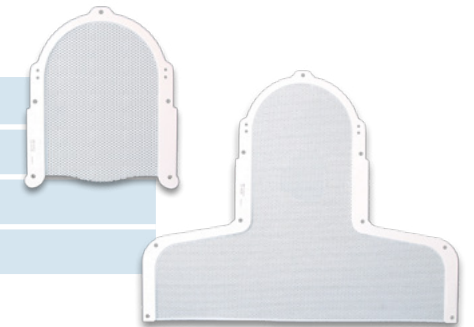

Aquaplast RT, Pediatric Standard Perforation

MTAPSP2.4	Head, Neck & Shoulders, Reloadable, 2.4 mm
20CFHNPSUB1P	Reloadable Frame

For more pediatric options, see page 111.



Aquaplast RT
Standard
Perforation

Type-S Thermoplastics

Masks on this page are disposable (unless otherwise noted) and sold in Qty 5.

ADDITIONAL AQUAPLAST RT THERMOPLASTICS

IMRT Reinforced	2.4 mm	3.2 mm
Style 18, Head Only, 12" Extended	-	MTAPUID181232
Style 18, Head Only, 14" Extended	-	MTAPUID181432
Style 20, Head Only	MTAPUID2024	MTAPUID2032
Style 22, Head Only	-	MTAPUID2232
Style 29, Head, Neck & Shoulders	MTAPSID2924	MTAPSID2932
Style 29, Head, Neck & Shoulders with Neck Relief	MTAPSID29NR24	MTAPSID29NR32
IMRT Reinforced, Reloadable	2.4 mm	3.2 mm
Style 18, Head Only	-	MTAPUIR1832
Standard Perforation	2.4 mm	3.2 mm
Head Only, 12" Extended	MTAPUD1224	-
Head Only, 14" Extended	MTAPUD1424	-
Standard Perforation, Reloadable	2.4 mm	3.2 mm
Head Only	MTAPUR2.4	MTAPUR
Head, Neck & Shoulders	-	MTAPS3.2
Solid w/ Perforated Nose	2.4 mm	3.2 mm
Head Only	MTAPUD002	-
Reinforcement Thermoplastic Strips	2.4 mm	3.2 mm
1.375 x 24" (3.5 x 70 cm), Qty 1	-	MTAPS18391
1.375 x 9.75" (3.5 x 25 cm), Qty 5	-	MTAPS25
1.375 x 13.75" (3.5 x 35 cm), Qty 5	-	MTAPS35

Lead times for these masks vary; contact your sales representative.

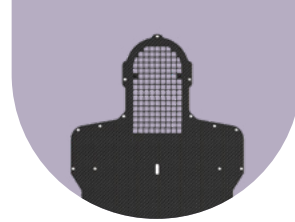

Style 18



Style 20



Style 22



Style 29

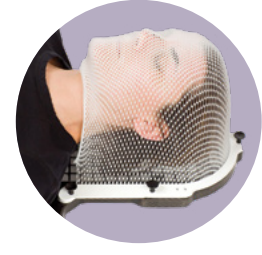

Standard Perforation

Uni-frame Baseplates

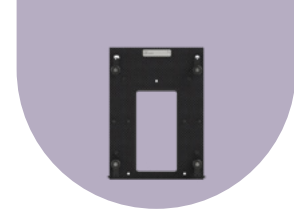

ProBoard™ Flat Carbon Fiber Headboard



Polycarbonate Headboard



Headboards

RT-4525TILT-A	ProBoard Flat Carbon Fiber Headboard
RT-4548	Polycarbonate Headboard
RT-4525TILT-B	Upgrade Kit - ProBoard for Tilt-Pro Tilting Base
RT-4484-16/4X6	Prone Mask Foam, Qty 8
RT-1969	Uni-frame Mask for use in prone technique*

*Mask is disposable and sold in Qty 1. Must purchase in multiples of 4.

Tilt-Pro™ Tilting Base

Tilt-Pro allows precise angling of the head for prone and supine treatments, avoiding critical structures. It adapts easily to most couchtops, simulator, and CT tables and is designed for one-step molding and positioning of Type-S and Uni-frame masks. Indexable channel arms adjust from 0 to 30° in 5° increments.

See page 99 for the ProBoard Flat Carbon Fiber Headboard.

ALSO COMPATIBLE WITH TYPE-S SYSTEM

RT-4525TILT	Tilt-Pro Tilting Base with Low-Pro Swivel Locks
-------------	---

Uni-frame Baseplates

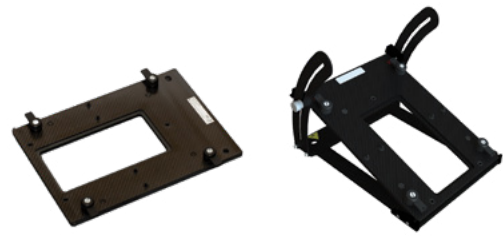

Carbon Fiber Supine Baseplate

MT20100CF	Standard
MT20103CF	Tilting

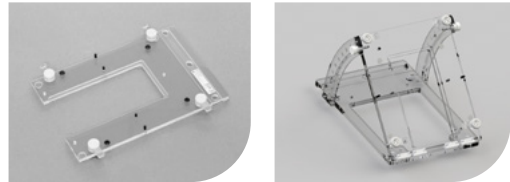

Acrylic Supine Baseplate

MT20100	Standard
MT20108	Standard, for use with Accuray Cyberknife®
MT20104	Tilting

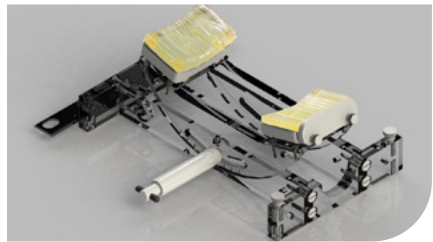

Prone Head Holder

The Prone Head Holder provides variable head angle positioning and features gel chin and forehead pads. This accessory unit integrates with the acrylic standard supine baseplate or the carbon fiber standard supine baseplate (MT20100, MT20100CF—see above) for patient fixation with a Uni-frame thermoplastic mask.

MT202

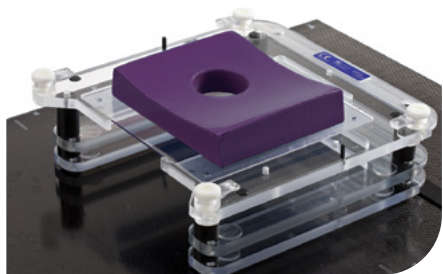

Lateral Baseplate

The Lateral Baseplate is specially padded for comfortable, reproducible lateral head & neck positioning. It accepts a special-width reloadable frame and thermoplastics and comes with a Lateral Head Cushion.

MTLTBP	Lateral Baseplate (includes lateral head cushion & reloadable frame)
MTLTBPIAT01	Lateral Head Cushion with Indexing Plate
MTLTBP2	Reloadable Lateral Frame
MTAPUL	Perforated 3.2 mm Thermoplastic, Qty 5
MTAPUL2.4	Perforated 2.4 mm Thermoplastic, Qty 5

Uni-frame Thermoplastics

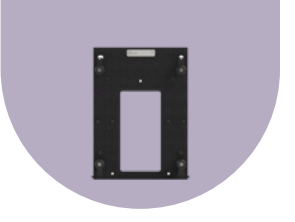

Masks on this page are disposable and sold in Qty 1. Must purchase in multiples of 5.

Traditional Frame

STANDARD PERF	
RT-1779	Aquaplast RT, 2.4 mm
RT-1889	Aquaplast RT, 3.2 mm
STANDARD PERF, LONG	
RT-1779L	Aquaplast RT, 2.4 mm
RT-1889L	Aquaplast RT, 3.2 mm

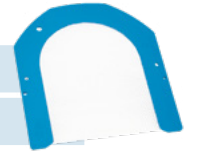

Slimline Frame

VARIABLE PERF	
RT-1889KYS	Fibreplast, 3.2 mm
RT-1889YS	Aquaplast RT, 3.2 mm
RT-1889YSR	Aquaplast RT, Open Eye & Mouth, 3.2 mm
STANDARD PERF	
RT-1779KS	Fibreplast, 2.4 mm
RT-1889KS	Fibreplast, 3.2 mm
RT-1779S	Aquaplast RT, 2.4 mm
RT-1889S	Aquaplast RT, 3.2 mm
RT-1989S	Aquaplast RT, 4.8 mm (must be purchased in multiples of 4)
STANDARD PERF, LONG	
RT-1779KSL	Fibreplast, 2.4 mm
RT-1889KSL	Fibreplast, 3.2 mm
RT-1779SL	Aquaplast RT, 2.4 mm
RT-1889SL	Aquaplast RT, 3.2 mm

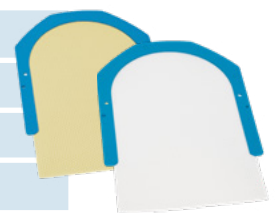

Uni-frame Thermoplastics

Masks on this page are disposable. Slimline Split are sold in Qty 1 and must be purchased in multiples of 5. All others are sold in Qty 5.

Slimline, Split Frame

VARIABLE PERF, LONG

RT-1889KYSGLF Fibreplast, Assure Open View, 3.2 mm

STANDARD PERF

RT-1889KS-S3 Fibreplast, 3.2 mm

RT-1889S-S3 Aquaplast RT, 3.2 mm



FreedomView, IMRT Reinforced Style 18

MTAPUI1832CL Aquaplast RT, Head Only, 3.2 mm



ClearVision

MTVRTW Aquaplast RT, Head Only, Wide, 3.2 mm



visionrt COMPATIBLE

For added customizable hold, see page 103 for Reinforcement Thermoplastic Strips.

ZENTEC, IMRT Reinforced Style 18

MTAPUI1824VT Head Only, 2.4 mm

MTAPUIW1824VT Head Only, Wide, 2.4 mm

MTAPUIW1832VT Head Only, Wide, 3.2 mm



Aquaplast RT, IMRT Reinforced Style 18

MTAPUI1824 Head Only, 2.4 mm

MTAPUI1832 Head Only, 3.2 mm

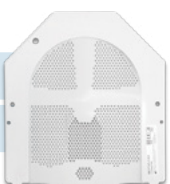

See Vision RT's compatibility statement on back cover.



FreedomView IMRT Reinforced Style 18



ClearVision



ZENTEC IMRT Reinforced Style 18



Aquaplast RT IMRT Reinforced Style 18

Uni-frame Thermoplastics

Masks on this page are disposable and sold in Qty 5.

Aquaplast RT, Standard Perforation

MTAPU2.4 Head Only, 2.4 mm

MTAPU Head Only, 3.2 mm

MTAPUW2.4 Head Only, Wide, 2.4 mm

MTAPUW Head Only, Wide, 3.2 mm

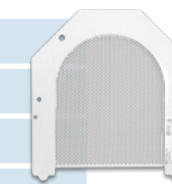

ADDITIONAL AQUAPLAST RT THERMOPLASTICS

Standard Perforation	1.6 mm	2.4 mm	3.2 mm
1.6 mm	MTAPU1.6	-	-
12" Extended	-	MTAPU122.4	MTAPU12
12" Extended, Wide	-	MTAPUW122.4	-
14" Extended	-	MTAPU142.4	MTAPU14

Reinforcement Thermoplastic Strips	1.6 mm	2.4 mm	3.2 mm
1.375 x 24" (3.5 x 70 cm), Qty 1	-	-	MTAPS18391
1.375 x 9.75" (3.5 x 25 cm), Qty 5	-	-	MTAPS25
1.375 x 13.75" (3.5 x 35 cm), Qty 5	-	-	MTAPS35

Lead times for these masks vary; contact your sales representative. All disposable thermoplastics are MR Safe.



Standard Perforation

Posifix Extensions

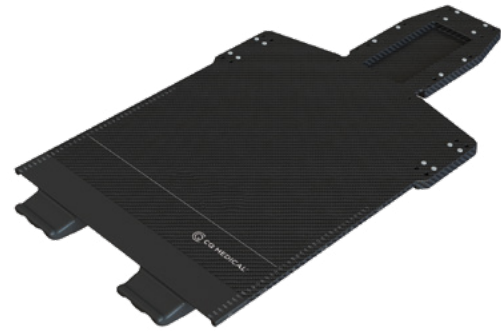

Universal Couchtop Long Extension

The Universal Couchtop Long Extension self-locks onto the Universal Couchtop, allowing the thermoplastic to connect to the couchtop.

See pages 10-13 for more info.

MTIL6666	Length: 39.1" (99.3 cm)
MTIL6672	Length: 49.1" (124.7 cm)

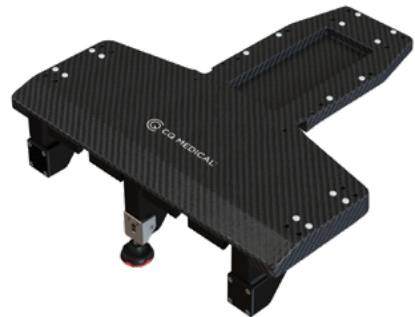

Varian Style Extension

The Varian Style Extension hooks easily on the superior end of the Varian style endplate. Like the Universal Couchtop extensions, this extension allows for 360° treatment of the head and neck with minimal attenuation.

108010	Varian Exact compatible
---------------	-------------------------

Posifix Baseplates



Head, Neck & Shoulders Baseplates

Carbon fiber or Acrylic Posifix baseplates for head only and head, neck and shoulder fixation.

102021	Posifix-2 Baseplate, Carbon Fiber
101019	Posifix-1 Baseplate, Acrylic, trUpoint ARCH SRS/SRT System compatible
013159	Two-Pin Baseplate Storage, compatible with two-pin Posifix and Posirest baseplates and most other two-pin ready baseplates

Posifix Variable Axis Baseplate

The Variable Axis Baseplate integrates with any Posifix extension, overlay or baseplate to provide a tilting movement with patient fixation in either prone or supine positions. The unique variable axis design allows for natural head and neck movement and features a rotating knob to lock the baseplate into an angle position from 0°-30° in supine position and 12.5°-32.5° in prone position. The baseplate accommodates Posifix head only thermoplastics and accepts all supine and prone Posifix headrests (sold separately).

See pages 117-119 for headrest options.



107065	Posifix Variable Axis Baseplate, Carbon Fiber
---------------	---



iBEAM® Overlay Adapter

Created for the Medical Intelligence iBEAM and iBEAM EVO couchtops. The overlay is cantilevered, providing minimal attenuation in the area of treatment.

108072	trUpoint ARCH SRS/SRT System compatible
---------------	---

Posifix Thermoplastics

Masks on this page are disposable and sold in Qty 1. Must purchase in multiples of 10.

Fibreplast & Aquaplast RT, Head Only (3-Point)

RT-1778KPR3DF	Fibreplast, Micro Perf, Assure Open View, 2.4 mm
RT-1782KPR3D	Fibreplast, Standard Perf, 2.4 mm
RT-1778KPR3D	Fibreplast, Micro Perf, 2.4 mm
RT-1782PR3D	Aquaplast RT, Standard Perf, 2.4 mm
RT-1778PR3D	Aquaplast RT, Micro Perf, 2.4 mm

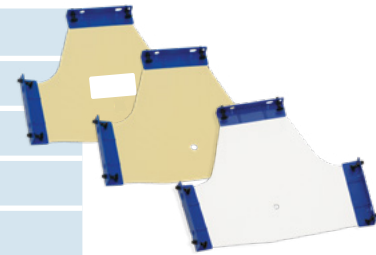

Fibreplast & Aquaplast RT, Head, Neck & Shoulders (5-Point)

RT-1778KPR5DF	Fibreplast, Micro Perf, Assure Open View, 2.4 mm
RT-1782KPR5D	Fibreplast, Standard Perf, 2.4 mm
RT-1778KPR5D	Fibreplast, Micro Perf, 2.4 mm
RT-1782PR5D	Aquaplast RT, Standard Perf, 2.4 mm
RT-1778PR5D	Aquaplast RT, Micro Perf, 2.4 mm

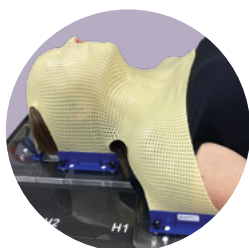
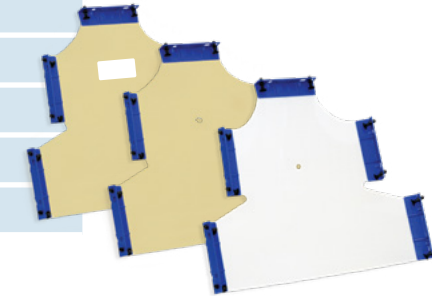

Head, Neck & Shoulders

Posifix Thermoplastics

Masks on this page are disposable and sold in Qty 10.

Posicast, Head Only

772030	Posicast-Lite, 2.3 mm
930030	Posicast-Plus, 2.3 mm
772044	Posicast-Lite with Larynx Extension, 2.3 mm
930044	Posicast-Plus with Larynx Extension, 2.3 mm



Posicast, Head Only, Open-face

970031	Posicast-Lite, trUpoint ARCH SRS/SRT System compatible, 2.3 mm
--------	---



Posicast, Head, Neck & Shoulders

772145	Posicast-Lite, 2.3 mm
930145	Posicast-Plus, 2.3 mm

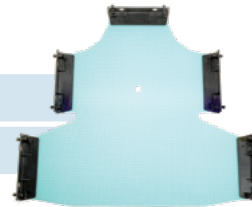

Posicast, Pediatric

930033	Posicast-Plus, Head Only, 2.3 mm
930055	Posicast-Plus, Head, Neck & Shoulders, 2.3 mm



For more pediatric options, see page 111.



Head Only



Head Only with Larynx Extension



Head Only with Open-face



Head, Neck & Shoulders

Posifix Thermoplastics



Chin Strap Thermoplastic

772021 Posicast, Qty 10



Shoulder Thermoplastic

MTAPSSPF Aquaplast RT, Solid, Qty 5



Posicast Microperfo Plate

924392 Micro perforation, fuzzy coating on one side. 43 x 92 cm, 2.3 mm thick, Qty 10.



Chin Strap Thermoplastic



Shoulder Thermoplastic

L-Profile Thermoplastic Masks

Masks on this page are disposable and sold in Qty 1. Must purchase in multiples of 10.

These masks allow for 3-point and 5-point immobilization utilizing a L-Profile design which locks into the device via the L design. They are available in Aquaplast RT and Fibreplast material in 2.4 mm and 3.2 mm thicknesses.

Head-Only (3-Point)

RT-1778KFORF3	Fibreplast, Micro Perf, Assure Open View, 2.4 mm
RT-1876KFORF3	Fibreplast, Micro Perf, Assure Open View, 3.2 mm
RT-1778KORF3	Fibreplast, Micro Perf, 2.4 mm
RT-1782KORF3	Fibreplast, Standard Perf, 2.4 mm
RT-1889KYFORF3	Fibreplast, Variable Perf, Assure Open View, 3.2 mm
RT-1782ORF3	Aquaplast RT, Standard Perf, 2.4 mm
RT-1778ORF3	Aquaplast RT, Micro Perf, 2.4 mm
RT-1882ORF3	Aquaplast RT, Standard Perf, 3.2 mm



Head, Neck & Shoulders (4-Point)

RT-1782ORF4	Aquaplast RT, Standard Perf, 2.4 mm
RT-1778ORF4	Aquaplast RT, Micro Perf, 2.4 mm



Head, Neck & Shoulders (5-Point)

RT-1782KORF5	Fibreplast, Standard Perf, 2.4 mm
RT-1778KORF5	Fibreplast, Micro Perf, 2.4 mm
RT-1778KFORF5	Fibreplast, Micro Perf, Assure Open View, 2.4 mm
RT-1876KFORF5	Fibreplast, Micro Perf, Assure Open View, 3.2 mm
RT-1889KYFORF5	Fibreplast, Variable Perf, Assure Open View, 3.2 mm
RT-1782ORF5	Aquaplast RT, Standard Perf, 2.4 mm
RT-1778ORF5	Aquaplast RT, Micro Perf, 2.4 mm



Pediatric ProForm Extension & Overlays



Universal Couchtop Pediatric ProForm Extension

The Universal Couchtop Pediatric ProForm Extension self-locks onto the Universal Couchtop, allowing the thermoplastic to connect to the couchtop.

MTIL6682K	Pediatric ProForm Head & Neck Extension, 48.7" (123.7 cm), includes Cushion Guide and UCT Patient Handles
------------------	---



Pediatric ProForm Overlays

The ProForm CT & Photon Treatment Overlay and MR Overlay allow for CT simulation or MR imaging of patients who will be treated on the Universal Couchtop ProForm Extension, allowing seamless transition from simulation to treatment.

PRO400K	Pediatric ProForm CT & Photon Treatment Overlay, 2-Pin Lok-Bar compatible, includes ProForm Cushion Guide and Patient Handles
----------------	---

PRO420K	Pediatric ProForm MR Overlay, 3-Pin Lok-Bar compatible, includes ProForm Cushion Guide and Patient Handles
----------------	--



See pages 209-213 for the complete ProForm offering.

Pediatric ProForm Thermoplastics



Masks on this page are disposable and sold in Qty 5. ProForm Thermoplastics are made from Aquaplast RT material.

FreedomView IMRT Reinforced Style 18

PRO430IM1832CL	Pediatric Head Only, 3.2 mm
PRO431IM1832CL	Pediatric Head, Neck & Shoulders, 3.2 mm

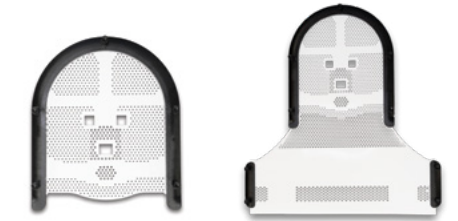

ClearVision 2

PRO430IM1832SG	Pediatric Head Only, 3.2 mm
PRO431IM1832SG	Pediatric Head, Neck & Shoulders, 3.2 mm



IMRT Reinforced Style 18

PRO430IM1832	Pediatric Head Only, 3.2 mm
PRO431IM1832	Pediatric Head, Neck & Shoulders, 3.2 mm

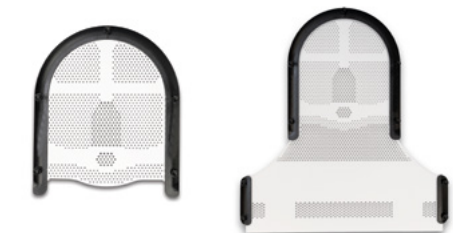

Standard Perforated

PRO430	Pediatric Head Only, 3.2 mm
---------------	-----------------------------



Registration Film

PRO440	Pediatric, Qty 5
---------------	------------------

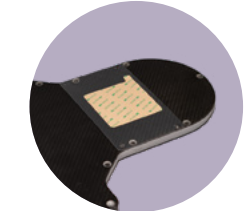

FreedomView IMRT Reinforced Style 18 Head Only



ClearVision 2 Head, Neck & Shoulders



IMRT Reinforced Style 18 Head Only



IMRT Reinforced Style 18 Head, Neck & Shoulders



Standard Perforated

Solstat™ Immobilization System

The Solstat system is comprised of a rigid head support, customizable cushion or non-custom headrest and a dedicated thermoplastic mask designed for secure and simple attachment. These components create a highly customizable, comfortable and rigid setup for accurate head and neck treatments.

- Midline thermoplastic mask attachment provides increased rigidity and minimizes shrinkage to enhance patient comfort
- Highly conformal to the patient when using a customizable cushion and dedicated thermoplastic mask
- Unique thermoplastic frame provides easy to use, secure and quiet mask attachment
- MR Safe



Head Support

Compatible with Type-S and Posifix Extensions, Baseplates and Overlays.

CHS05	Posifix, Qty 1
CHS06	Type-S, Qty 1

Aquaplast RT Thermoplastics

MTAPCID1832SG	ClearVision, Standard (left photo), Qty 5
MTAPCIN1832SG	ClearVision, Narrow, Qty 5
MTAPCID1832	IMRT Reinforced, Standard (right photo), Qty 5
MTAPCIN1832	IMRT Reinforced, Narrow, Qty 5
MTAPSSTS	Shoulder, Type-S (left photo), Solid, Qty 5
MTAPSSPF	Shoulder, Posifix (right photo), Solid, Qty 5

Headrests

CHS40K	Headrest Kit (includes B, C, & F), Qty 3
CHS40	Headrest B, Black, Qty 1
CHS41	Headrest C, Black, Qty 1
CHS42	Headrest F, Black, Qty 1

AccuForm Cushions

MTACL2035	20 x 35 cm Chamfered, Qty 1
MTACL2035HF	20 x 35 cm Chamfered, 1/2 Fill, Qty 1

Precise Bite

See page 116 for additional options.

MTCBPBITE	Standard, Qty 5
MTCBPBITES	Small, Qty 5

See Vision RT's compatibility statement on back cover.

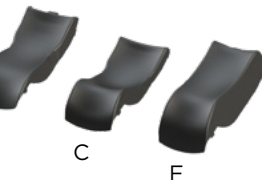
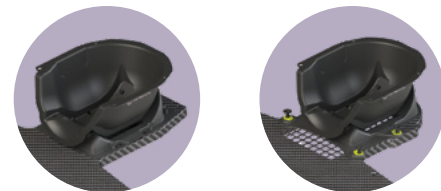

GrayDuck Stent™ Oral Positioning Device

GrayDuck Stent and GrayDuck Dart are currently the only custom fitted bite block systems that can position the tongue in one of several positions; laterally (left or right), depressing (downward) or a combination thereof.

- Tongue-displacing and immobilizing oral stent
- Capable of providing repeatable tongue deviation and immobilizing in several directions
- Designed to provide repeatable immobilization and tissue sparing during radiotherapy
- Ergonomically developed to be a quick, easy-to-fit custom oral stent

GDS002	GrayDuck Original, Size Small, Qty 4
GDS001	GrayDuck Original, Size Medium, Qty 4



GrayDuck Stent, Original. Each Kit includes small or medium stent, 3 paddles, and 2 struts.

GrayDuck Dart™

The GrayDuck Dart is an improved version of GrayDuck Stent, offering a significantly smaller and easier-to-use stent while retaining the same level of customization as described above.

- Smaller stent size increases patient tolerance and improved insertion for patients with limited bite opening
- Three simple steps allow for faster workflow
- Spacers allow for increased bite opening, if needed
- Universal stent orientation allows placement in patient's mouth on either arch tray side

GDS003	GrayDuck Dart, Qty 4
--------	----------------------

CE MARKED, 510(K) CLEARED
US PATENT #9,504,537 AND OTHER PATENTS PENDING

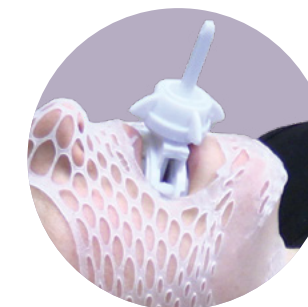

GrayDuck Dart is 55% smaller than the original stent design

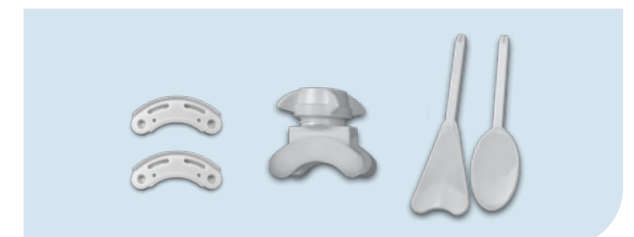

GrayDuck Dart. Each Kit includes dart stent, 2 paddles, and 2 spacers.

Customizable Head Support

The Customizable Head Support is a shell and customizable cushion system. The unique shape of the shell was designed to encourage the cushion to return the patient to a repeatable position from fraction to fraction.

- Allows more support under patient's neck for less superior-inferior movement (pitch)
- Provides enhanced comfort so patient is less likely to move during treatment
- Two small pins centered inside the shell provide fixed, repeatable points while preventing the cushion from moving
- Deep "bowl" shape provides a deeper head capture than using a cushion alone or standard head supports
- Compatible with Vision RT's Align RT camera system when used with ClearVision Thermoplastic

CHS01	Posifix
CHS02	Type-S
MTACL2035HF	20 x 35 cm Chamfered AccuForm, 1/2 Fill
MTACL2035	20 x 35 cm Chamfered AccuForm

See Vision RT's compatibility statement on back cover.



Posifix with 20 x 35 cm AccuForm



Type-S with 20 x 35 cm AccuForm

Shoulder Retractor

The Shoulder Retractor is often used with thermoplastic-based fixation systems. Retraction is especially beneficial for shoulder clearance when opposing lateral fields are used to treat the neck.

- Constructed of durable plastic with a large footboard and nylon tension ropes with ball-in-socket locking, allowing for selectable tension in 1/2" increments
- Available with Handle Grips, Sherpa Wrist Loops or washable Nylon Wrist Loops

MTSR01	Retractor with Handle Grips (left photo)
MTSR02	Retractor with Sherpa Wrist Loops (middle photo)
MTSR03	Retractor with Nylon Wrist Loops (right photo)

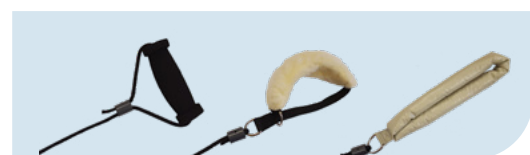

AccuForm™ Cushions

AccuForm Cushions are ideal for high-precision head and neck treatments when enhanced comfort, stability and repositioning accuracy are key.

- Soft, cloth-covered pillow contains tiny beads coated in water-curable resin
- Cushion becomes pliable when sprayed with water, allowing formation around patient's contours, including custom pitch and rise
- Cushion forms a rigid, comfortable custom mold when dry
- Single patient use
- 15 x 20 cm cushion recommended when customized fit is needed on a standard headrest
- 20 x 25 cm, 20 x 45 cm and Type-S cushions can be used as stand-alone cushions
- 20 x 35 cm chamfered cushion features clipped cushion corners that provide support without interfering with the thermoplastic

MTACL1520	15 x 20 cm AccuForm
MTACL14242	20 x 25 cm AccuForm
MTACL2035	20 x 35 cm Chamfered
MTACL2035HF	20 x 35 cm Chamfered Half Fill
MTACL2035U	20 x 35 cm AccuForm U Shaped
MTACL2045	20 x 45 cm AccuForm
MTACL4060	40 x 60 cm AccuForm
MTACL6060	60 x 60 cm AccuForm
MTACL5865T	58 x 65 cm AccuForm Trapezoid, Head, Neck & Shoulders
MTACLTYPE1	55 x 65 cm AccuForm, Type-S
MTACLTYPE2	47 x 58 cm AccuForm, Type-S

AccuForm Positioner

An AccuForm Positioner can be used for indexing an AccuForm cushion to Uni-frame and Type-S baseplates.

MTACL001

AccuForm Shim

The AccuForm Shim is a flexible, thin foam piece that provides a small height offset above the customized patient AccuForm. The shim is intended to be placed onto the formed AccuForm cushion, and prior to forming the thermoplastic mask.

Using the shim can counteract suspected mask shrinkage and/or patient swelling, increasing patient comfort while maintaining ideal immobilization.

MTACLSHIM	Qty 10
------------------	--------



15 x 20 AccuForm

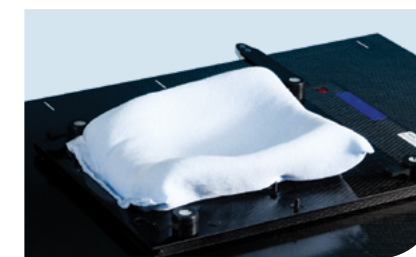

20 x 25 AccuForm



Type-S AccuForm

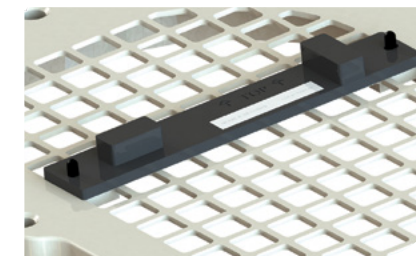

AccuForm Positioner



AccuForm Shim

Precise Bite™

The Precise Bite attaches easily to a thermoplastic cast and conforms to the teeth and/or maxilla to aid in effective and repeatable positioning. The Precise Bite with tongue depressor assists in tongue displacement and provides an airway opening for easy breathing.

MTCBPBITE	Standard, Qty 5
MTCBPBITETD	Standard w/ Tongue Depressor, Qty 5
MTCBPBITES	Small, Qty 5
MTCBPBITETDS	Small w/ Tongue Depressor, Qty 5
MTCBPBITEWRM	Warmer, 110 volt

WARMER HAS NOT BEEN CE MARKED. CONTACT YOUR SALES REPRESENTATIVE FOR COUNTRY COMPATIBILITY.



IntegraBite™

The IntegraBite bite plate provides repeatable positioning and decreases patient head and neck rotation, flexion, and extension. The simple and streamlined design makes application and insertion easy.

RT-A001	Qty 5
---------	-------

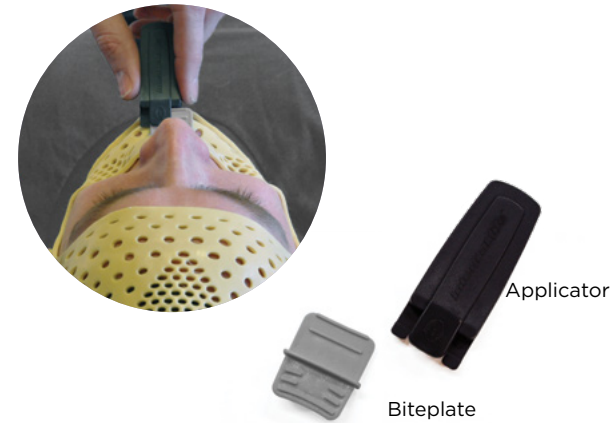

Headrests

Silverman Headrests

With a Silverman, no transmission correction is necessary for most high-energy beams. Silverman headrests can be purchased individually or in a set of six.

The Silverman Q1 and Q2 minimize overstretching of the mask while simultaneously offering cranial support.

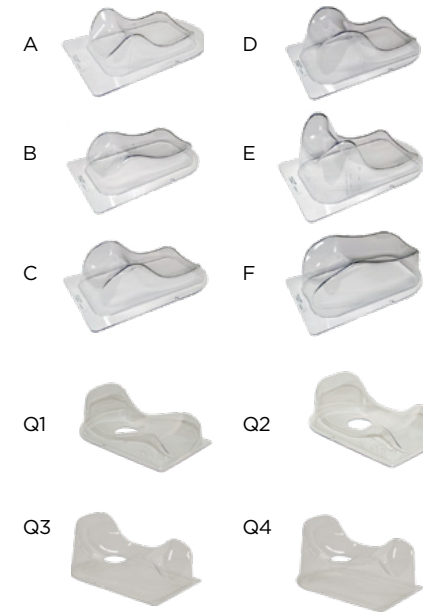

MTSILVER2A	A
MTSILVER2B	B
MTSILVER2C	C
MTSILVER2D	D
MTSILVER2E	E
MTSILVER2F	F
MTSILVER2	Set of six, sizes A-F
RT-4491-Q1	Q1
RT-4491-Q2	Q2
RT-4491-Q3-2G	Q3
RT-4491-Q4-2G	Q4

Shims

Shims are for use with headrests and systems.

MTSHIMS	Silverman
MTSHIMT	Timo
MTSHIM01	Type-S Head Only
MTSHIM01S	Type-S Head, Neck & Shoulders

Headrest shape may have slight variations; the same headrest should be used for a patient throughout setup and treatment cycle.

Headrests

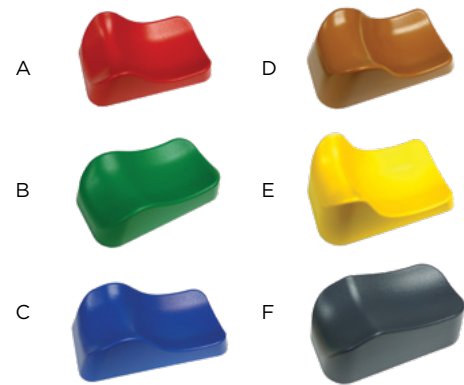

Timo Headrests

Timo headrests are constructed of durable polyurethane foam with a washable coating. Six various heights and contours offer a comprehensive range of neck angulations. They are available plain or with Lexan plates for use with Uni-frame baseplates and Wing Boards.

Add "L" to any "MT" part number to add Lexan Plate.

MTTIMO2A	A, Red
MTTIMO2B	B, Green
MTTIMO2C	C, Blue
MTTIMO2D	D, Brown
MTTIMO2E	E, Yellow
MTTIMO2F	F, Gray
MTTIMO2	Set of six
MTTIMO2L	Set of four (A, B, C, F) w/ Lexan Plates

Extended Head Stop Headrests

The Extended Head Stop Headrests help encourage patients to return closer to the same position from treatment to treatment by providing a cranial stop as a reference for where to place their head.

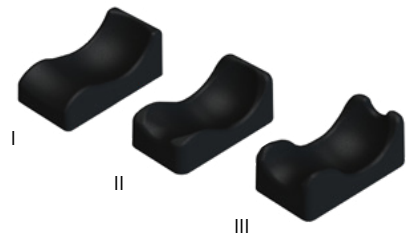

301030	I, Large
301032	II, Medium
301033	III, Small
301034	Set of three

Posifix Supine Headrests

Posifix headrests are made of low density polyethylene foam.

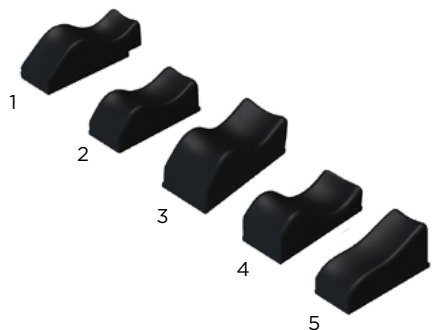

301201	1, Similar to #2 with patient shift in superior direction
301202	2, Natural position
301203	3, Slightly hyperextended
301204	4, Hyperextended
301205	5, Chin down toward chest
305001	Set of five

Headrest shape may have slight variations; the same headrest should be used for a patient throughout setup and treatment cycle.

Headrests



Posifix Contoured Headrests

The Posifix Contoured Headrests feature colored bottoms for easy identification and are wider and higher than the standard Posifix supine headrests, completely surrounding the back of the head. This design is intended to encourage less lateral, longitudinal and rotational movement during setup and treatment.

301023	Yellow bottom, Slightly hyperextended
301024	White bottom, Hyperextended
301022	Orange bottom, Natural position
301234	Set of three

Posifix Wide Headrest

A special wide headrest, made of low density polyethylene foam, is available in a natural position design.

301008A

Posifix Prone Headrest

The Prone Headrest is specially designed for treatments with the patient in the prone position. The 3-D shaped contour supports chin and forehead and therefore, assists in creating a reproducible and comfortable position.

301025BLK

Posifix Pediatric Headrests

Designed for use with pediatric patients. Both the prone and supine headrests are available in bright, glossy colors.

301026	Supine
301027A	Prone

Headrest shape may have slight variations; the same headrest should be used for a patient throughout setup and treatment cycle.

Headrests

Prone Head Cushion & Adapter

Designed to support the patient's head while in the prone position. The contoured shape supports the chin and forehead providing comfortable and reproducible positioning. The Head Cushion Adapter allows the Prone Head Cushion to be mounted to any device that uses Silverman locating pins.

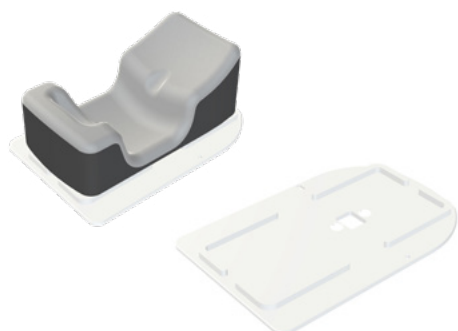

RT-4552P	Prone Head Cushion (shown on Head Cushion Adapter that is sold separately)
RT-4552A	Head Cushion Adapter for Silverman Pins

Headrest shape may have slight variations; the same headrest should be used for a patient throughout setup and treatment cycle.

Spacers & Wedges

NEW SPACERS & WEDGES ARE NOW MR SAFE!

Spacers & Wedges are available in a variety of heights and angles for use with the Posifix Patient Positioning System to provide positioning offset of the patient for unique treatment needs. They can accommodate the use of all Posifix style headrests, Extended Stop Headrest, Posifix Customizable Head Support and Posifix Individual Head Support in MR, CT, and treatment environments.

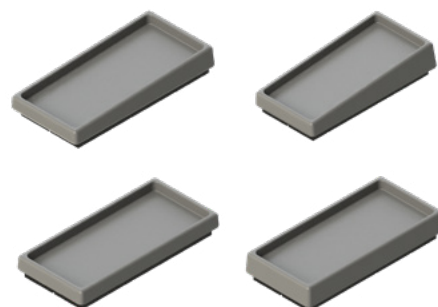

107101MR	Wedge, 2.5°
107102MR	Wedge, 5°
107103MR	Spacer, 20 mm
107104MR	Spacer, 30 mm
107106MR	Spacers & Wedges. Set of four includes: Wedges 2.5° and 5°, Spacers 20 and 30 mm

Direct Indexing™ Adapters

REQUIRED WHEN EXTENDING A STANDALONE DEVICE BEYOND THE END OF THE COUCHTOP:



RT-4527EXA Varian Exact IGRT Couchtop (Two hand grip posts included)	RT-4527LMI3 Elekta/Medical Intelligence I-Beam and Tomotherapy (Two hand grip posts included)	RT-4527QFIX CQ Medical kVue & QUANTUM	RT-4527EXAG Varian Exact Couchtop
--	---	---	---

FOR ATTACHING A STANDALONE DEVICE TO CT OVERLAYS:



RT-4529M Varian Exact compatible CT (4 black discs included)	RT-4527QFIX CQ Medical kVue & QUANTUM	RT-4527LTOMO Tomotherapy Adapter
--	---	--

Adapters

Headrest Adapters

Headrests provide enhanced repositioning, accuracy and patient comfort. Many headrests are compatible with our three head & neck patient positioning systems (Type-S, Posifix or Uni-frame) and Wing Boards directly or via an adapter.

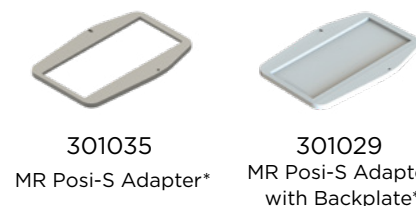

301035*	MR Posi-S Adapter
301029*	MR Posi-S Adapter with Backplate

*The 301035 and 301029 do not provide equivalent setups. Customers using 301029 should reorder that part number. New customers should order 301035.

RapidHeat™ Oven

RAPIDHEAT HOT AIR OVEN FOR THERMOPLASTIC MASKS, SHEETS, AND PELLETS

Quickly reaches working temperatures and provides an easy-to-use method to heat thermoplastic masks as well as Aquaplast RT thermoplastic sheets and pellets. Its unique two fan design and optimal spacing between racks allows the hot air to soften the thermoplastic quickly and evenly. RapidHeat has a large 75 mm high digital display that features a Quick Start Guide to easily navigate operating the oven. The digital temperature controller can be used in a programmable or manual timer mode, increasing workflow efficiencies.

- Easily preheat the oven while prepping the patient
- Digital timer counts down from the designated time and alerts when ready
- Minimizes cross contamination
- Non-stick ball-bearing sliding racks for easy cleaning and removal of masks

Dimensions (W x D x H)
 Overall: 32 x 30 x 19.1" (81.3 x 76.2 x 48.5 cm)
 Internal: 27 x 21 x 10" (68.6 x 53.3 x 25.4 cm)

RT-2075-110	RapidHeat Oven, 110 Volts
RT-2075-220*	RapidHeat Oven, 220 Volts

* Comes standard with European plug.

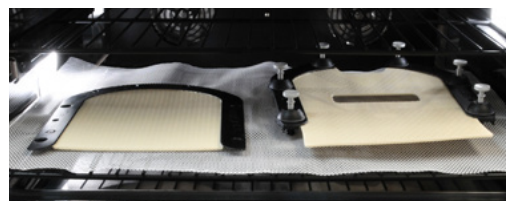

Water Bath

The Water Bath accommodates all thermoplastic sizes including Type-S head, neck and shoulders, HipFix, and ThermFix thermoplastics.

Dimensions (W x D x H)*
 Overall: 31.25 x 24 x 13" (79.37 x 60.96 x 33.02 cm)
 Internal: 25 x 19 x 5" (63.5 x 48.3 x 12.7 cm)

MTRH1500	120V
MTRH1500EX	230V
MTCBPLLG	Pan Liner, Large, Qty 2

*Dimensions do not include shut off valve mounted on side.



Warmer

The Precise Bite Warmer softens a Precise Bite, GrayDuck Stent, or GrayDuck Dart without a microwave or water bath.

See page 66 for more information

MTCBPBITEWRM	Warmer, 110 volt
--------------	------------------

CONTACT YOUR SALES REPRESENTATIVE FOR COUNTRY COMPATIBILITY. THIS PRODUCT HAS NOT BEEN CE MARKED.



Dry Heat Oven/Waterbath Stand **NEW!**

The stainless-steel Dry Heat Oven/Water Bath Stand is an efficient way to store or transfer a dry heat oven or water bath in and between treatment rooms. The stand can be changed to a mobile cart by assembling a set of four lockable casters.

Dimensions (W x D x H)
 Without Casters: 36 x 30 x 24" (91.44 x 76.2 x 60.96 cm)
 With Casters: 36 x 30 x 28" (91.44 x 76.2 x 71.12 cm)

Load Capacity
 Without Casters: 750 lbs / 340 kg
 With Casters: 500 lbs / 226 kg
 Bottom Shelf: 175 lbs / 79 kg

RT-2111C	Dry Heat Oven/Water Bath Stand
RT-2111C-WLS	Lockable Casters (shown, sold separately), Qty 4





You and your breast cancer patients shouldn't have to conform to a breastboard

IN ANY WAY, SHAPE OR FORM.

For breast cancer treatment, supine breastboards that configure to your patients, as well as to your clinical needs, are what we're all about. At CQ Medical, we offer a full lineup to put your patients, and your clinicians, equally at ease.

 **CQ MEDICAL™**
Care Smarter

Breast & Thorax



130-132
C-QUAL M & C-QUAL
BREASTBOARD



133-136
ACCESS SUPINE DEVICES



137-138
EVOLVE
BREASTBOARD



139-142
ACCESS 360 G2 PRONE
BREAST INSERT & DEVICE

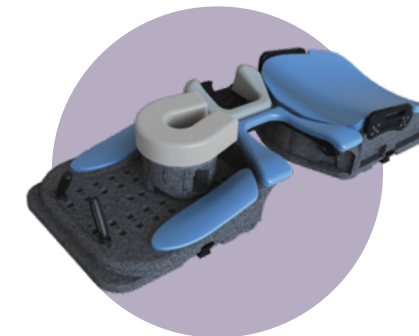

143
NEW HORIZON PRONE
BREASTBOARD

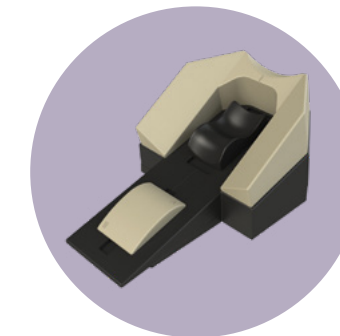

143
THORAWEDGE



144
WING BOARDS



145
TREATMENT BRASSIERE



162 & 164
VACUUM CUSHIONS

CHOOSING A SUPINE BREAST & THORAX POSITIONING SYSTEM*

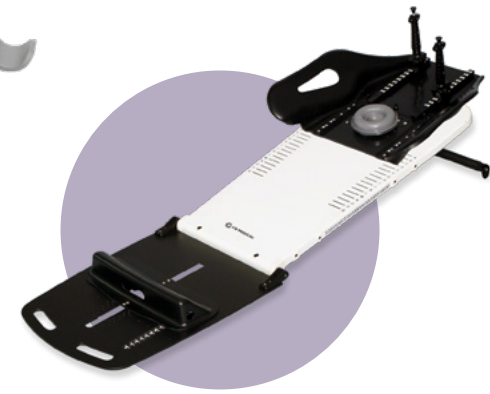

C-Qual M™	C-Qual™
-----------	---------

Page 130	Page 132
----------	----------

ARM & HAND SUPPORT OPTIONS	Monarch Overhead Arm Positioner	Arm & Wrist Supports, Monarch Overhead Arm Positioner
HAND GRIP OPTIONS	M Handle, Individual Hand Grips	M Handle, Individual Hand Grips
TREATMENT COMPATIBLE	Photon, Proton	Photon
IMAGING COMPATIBLE	CT, MR	CT
BACK BOARD MATERIAL	Kevlar, Foam Core	Carbon Fiber
ELEVATION SUPPORTS	5°-25° (nine indexable tilt positions)	5°-25° (nine indexable tilt positions)
HEAD SUPPORT OPTIONS	Posifix® Headrests	Posifix Headrests
BREAST THERMOPLASTICS	Yes (one indexing position)	Yes (one indexing position)
HEAD THERMOPLASTICS	Yes (Posicast Head Only and Chin Strap)	Yes (Posicast Head Only and Chin Strap)
VAC-LOK OPTION	Yes	Yes
BACK BOARD ATTENUATION	3.7% @ 6MV (back support & base)	3.11% @ 6MV (back support & base)
CLEAR SUPRACLAV REGION	Yes	Yes
BOTTOM BOARD	Permanent	Permanent

Access™ MR	Access	Evolve®
------------	--------	---------

Pages 133-136	Pages 133-136	Page 137
---------------	---------------	----------

Arm & Wrist Supports, ArmShuttle Elite (interchangeable)	Arm & Wrist Supports, ArmShuttle Elite (interchangeable)	Pro, Extended or Standard Wing Boards, Monarch Overhead Arm Positioner
ArmShuttle Posts	ArmShuttle Posts	T-Handle, U-Handle, Pro Handles, M Handle, Delrin Handles
Photon	Photon	Photon
CT, MR	CT	CT, MR
Foam Core Composite	Carbon Fiber	Glass Fiber, Foam Core
0°-25° (eight indexable tilt positions)	0°-25° (eight indexable tilt positions)	5°-15° (five indexable tilt positions)
Foam, Gel Cup, TIMO B Headrest, Silverman	Foam, Gel Cup, TIMO B Headrest, Silverman	Posifix Headrest w/ adapter, Round Foam, Gel Cup, Timo w/ Lexan plate or adapter
Yes (one indexing position)	Yes (one indexing position)	Yes (two indexing positions)
Yes (Type-S Chin Strap, Head Only and Head, Neck & Shoulders)	Yes (Type-S Chin Strap, Head Only and Head, Neck & Shoulders)	Yes (Chin Strap)
Yes	Yes	Yes
Contact Sales Manager	Contact Sales Manager	2.36% @ 6MV
Yes	Yes	Yes
Permanent	Permanent	Optional

*These breastboards offer many configurations and compatibilities. Please consult your sales representative for more information.

C-Qual M with Monarch™ Overhead Arm Positioner



The C-Qual M Breastboard features integration with the Monarch Overhead Arm Positioner, providing an efficient approach for arms-up positioning and allowing proper superior/inferior adjustment of the board to the patient which helps reduce patient slide.

- Matches body contours for optimal arm support and patient comfort
- Contoured cutouts in shoulder region help reduce attenuation during posterior axillary boosts
- Two hand grip designs allow for customized placement of each hand and arm
- Easy on/off latch system of the Monarch Overhead Arm Positioner eliminates need for tools to make adjustments
- Optical Surface Monitoring System (OSMS) compatible
- Elevation Supports secure angles from 5° to 25° with nine different tilt positions
- Compatible with Posicast Head Only and Chin Strap Thermoplastics (with Monarch or board-only), Breast Support Thermoplastics, Posifix Headrests and Vac-Lok Cushions

MTM400 C-Qual M with Monarch

Wall Storage device available, see page 224

Breast Support Thermoplastic

These thermoplastics for breast positioning require two reusable handles that mount to the C-Qual M, C-Qual, Evolve Breastboards.

	2.4 MM	3.2 MM	
Standard Perforated	MTRFX9182.4	MTRFX918	
IMRT Reinforced	MTRFI9182.4	MTRFI918	
Breast Support Handle System, Qty 2	-	-	MTRFH3



Featuring Individual Hand Grips



Mask can attach directly to incline board



Monarch Overhead Arm Positioner

The Monarch Overhead Arm Positioner is 23.4" (59 cm) wide and features two hand grip designs; a one-piece M Handle or individual hand grips. Each option can be adjusted a total of 24 cm and the individual grips can adjust in 2.2 cm increments for customized placement of each hand/arm.

- Matches body contours for optimal arm support and patient comfort
- Indexable for easy stand-alone use
- Compatible with Posicast Head Only and Chin Strap Thermoplastics with use of Monarch Thermoplastic Frame

OAP110	Monarch (includes M Handle, Tracks and Headrest)
OAP221	Pro Individual Hand Grips, Qty 1
OAP170	M Handle Tracks (2 each) (for Monarchs purchased prior to January 2019)
OAP180	Individual Hand Grips (2 each) and Tracks (set of 2) (for existing Monarch customers prior to January 2019)

Thermoplastic Option

Posicast thermoplastics are drape-style masks that require less stretching, therefore resulting in minimal shrinkage after cooling.

OAP120	Monarch Thermoplastic Frame
970031	Posicast-Lite Head Only (3 pt) with Open-face, 2.3 mm, Qty 10
772021	Chin Strap Thermoplastic, Qty 10

Wing Board Vac-Lok

Wing Board Vac-Lok creates a rigid and secure support around the patient when a vacuum is drawn through a self-sealing quick-release valve. See page 162 for more information.

VLWGB04C	108 x 55 cm, 17 L, Nylon (also compatible with Pro Wing Board)
VLWGB05C	108 x 55 cm, 14 L, Nylon w/ Head Support Cutout



Monarch Thermoplastic Frame allows for attachment of Posicast Head Only or Chin Strap Thermoplastics



Monarch with 108 x 55 cm Wing Board Vac-Lok

C-Qual Breastboard

The carbon fiber C-Qual Breastboard is lightweight, designed for patient comfort and features a low-attenuating IGRT treatment zone. The C-Qual's advanced features bring efficiencies to breast setup and treatment.

- Elevation Supports secure angles from 5° to 25° with nine different tilt positions
- Advanced arm supports, with no interference in the supraclavicular region
- Compatible with the Monarch Overhead Arm Positioner
- Compatible with Posicast Head Only Thermoplastics (page 107) and Breast Support Thermoplastics (page 130)
- Special wide headrest included

MT401	C-Qual with Monarch. Includes M Handle and Tracks compatible with the Individual Hand Grips (hand grips sold separately).
MT400	C-Qual with Arm & Wrist Supports
OAP100	Monarch (upgrade kit for MT400). Includes M Handle and Tracks compatible with the Individual Hand Grips (hand grips sold separately).
OAP120	Monarch Thermoplastic Frame

Wall Storage device available, see page 224
 Monarch Individual Hand Grip options available, see page 131



C-Qual with Monarch Overhead Arm Positioner



C-Qual with Arm & Wrist Supports

Access Supine & Access Supine MR

The Access Supine positions the patient's chest and thorax for external beam radiotherapy. The ladder system secures the backrest at various angles while the tailbone pad and bottom stopper comfortably support the patient for the duration of imaging and treatment.

- Accessories fix securely to the device so that they remain in place for storage and workflow efficiency
- Ladder system indexes patients at 0°, 5°, 7.5°, 10°, 12.5°, and 15° angles for breast treatments
- Optional 20° and 25° ladder set sold separately

RT-4546MRI	Access Supine MR Breast & Lung
RT-4546	Access Supine Breast & Lung with Carbon Fiber Grid
RT-4546-02	Access Supine Breast & Lung without Carbon Fiber Grid
RT-4546-01	Access Supine Breast Only with X-Trans™ base

Access Wall Mount available, see page 224

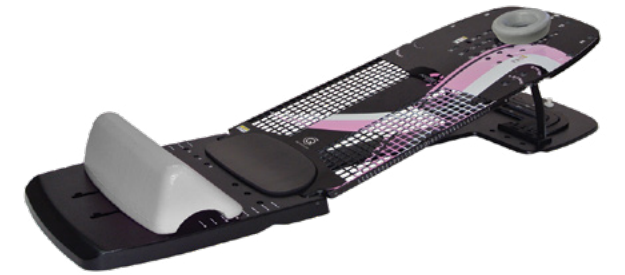

Foam bottom stopper and headrest Included. Arm Support Options sold separately, see page 134.



Built-In Ladder System Included. Accessory Ladder Set Sold Separately.



Indexing Scale on device



MR Safe with ArmShuttle Elite

With Carbon Fiber Grid with Arm & Wrist Supports

Without Carbon Fiber Grid with Arm & Wrist Supports

With X-Trans Base with Arm & Wrist Supports

Access Supine Arm Support Options



ArmShuttle™ Elite

The ArmShuttle Elite allows for full arms up positioning technique. The ribs of the shuttle index vacuum cushions and aid in ease of setup for daily treatments. The ArmShuttle Elite can affix to Access MR and Access Supine devices. It is possible to index directly to treatment couchtops for standalone use.

RT-4546C	ArmShuttle Elite with foam headrest and posts (w/ no indexing scales) (bottom-left photo)
8003020	ArmShuttle Post with Indexing Scale, 1 Post (sold separately) (bottom-right photo)



Arm & Wrist Supports

Independently adjustable Arm & Wrist Supports position the patient's arms out of the treatment field while exposing the chest for breast and nodal imaging and treatment. The ability to customize each patient's arm and wrist position also helps to increase comfort for patients with incisions while minimizing skin folds.

- Turn knob allows quick and ridged indexing of the Arm Support
- Wrist Supports rotate and are height adjustable
- Pads are easily removed for cleaning

RT-4546AW-01	Access Wrist Support (left photo)
RT-4546AA-01	Access Arm Support (right photo)



Access Supine Customization



Portrait Head & Shoulder Thermoplastic Adapters

Portrait Head & Shoulder thermoplastic adapters allow head and neck treatment for patients that are unable to lie flat. Portrait Head Only Adapter is supplied with mounting provisions for a chin strap.

RT-4546-03	Portrait Head Only Adapter (left photo)
RT-4546-04	Portrait Head & Shoulder Adapter (right photo)



Thermoplastic Chin Strap

Aquaplast RT Thermoplastic Chin Strap is designed to be used with the Portrait Head Only Adapter for Access Supine Breast Devices to keep the patient's head out of the treatment field.

RT-1778PR2DC	Aquaplast RT Chin Strap, Qty 4
--------------	--------------------------------



Thermoplastic Breast Adapter

This device increases functionality by providing the ability to attach thermoplastic sheets to the Access Supine. This increases reproducibility of breast positioning for treatment. The device works in conjunction with 14" Opti-Handles to secure thermoplastics to the Access Supine.

RT-4546-05	Access Supine Thermoplastic Breast Adapter
RT-4454-14	Opti-Handles, 36 cm (14 in.)
RT-1783P3	Aquaplast Standard Perf (30 cm x 45 cm x 2.4 mm)

Access Supine Customization



Accessory Ladder securely attaches to mount on the baseplate

Accessory Ladder Set

Accessory Ladder Set elevates the backrest to 20° & 25° angles for increased imaging and treatment options.

RT-4546L Accessory Ladder Set



ArmShuttle Elite with Adapter and Silverman headrest

Silverman Adapter for Breast Devices & ArmShuttle

Easily indexes Silverman headrest for enhanced repositioning, accuracy, and patient comfort.

RT-4543S Silverman Adapter for Access Breast Devices & ArmShuttle (Note: Silverman Adapter is transparent)

Headrests



RT-4494 Gel Donut, 200mm, Standard

RT4494-P Gel Donut, 150mm, Small

Evolve Breastboard

The Evolve Breastboard is a lightweight solution that allows quick and simple indexing of many Wing Boards which aids in reproducibility without sacrificing patient comfort. Many hand grips, headrests, and thermoplastic options easily integrate to maximize positioning options based on patient or clinical need.

- CT, MR, photon and SGRT treatment compatible
- Indexing marks allow reproducible setup
- Side scales assist with alignment
- Compatible with Breast Support Thermoplastics (page 130) and Wing Board Vac-Lok Cushions (page 162)
- Indexable to TotalRT Platform or other couchtops via two- or three-pin Lok-Bar
- Indexable with or without the optional bottom board



SIMPLE ELEVATION ADJUSTMENT

Support bar secures the board from 5° to 15° with five adjustable elevation angles. Simply lift the superior end of the board and push the handle to adjust the elevation.

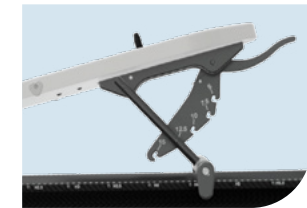

INTEGRATED GLIDETRACK™

Allows simple positioning of the Pro, Extended and Standard Wing Boards to accommodate patients of varied torso lengths.



A MODULAR APPROACH TO BREAST & THORAX POSITIONING



Evolve with Pro Wingboard

Evolve with Extended Wingboard

Evolve with Standard Wing Board and no Bottom Stop

Pro Wing Board

The Pro Wing Board is 23.4" (59 cm) wide and features Individual Hand Grips that are easily adjustable 24 cm on a track in 2.2 cm increments for customized placement of each hand/arm. Four headrest options (Gel Head Rest, Round Head Cup, Posifix Headrests, and Timo Headrests) are indexable in multiple positions.

- Contoured cutouts in shoulder region eliminate attenuation during posterior axillary boosts
- Four handle options can be used (Pro Handles, M Handle, T or U Grip)
- Chin thermoplastic can attach to position patient's chin away from the beam
- Three-pin indexable for stand-alone use



OAP220 Pro Wing Board with Pro Handles and Gel Head Rest

Pro Wing Board Accessories



- OAP140 M Handle
- OAP223 T-Grip & Track
- OAP224 U-Grip & Track
- 772021 Chin Thermoplastic, Qty 10
- MT250SUB11 Round Head Cup
- OAP121 Pro Posifix Headrest Adapter

CREATE YOUR BREASTBOARD SETUP

Evolve Breastboard Package

MTM500 Includes Slant Board, Bottom Board, Bottom Stop, Pro Wing Board, Pro Handles and Gel Head Cup

Evolve Slant Board, Bottom Board & Bottom Stop

OAP240

Evolve Slant Board

OAP200

Evolve Type-S Locating Kit

OAP300 Includes Evolve Type-S Locating Bar and Slide Guide Three-Pin Lok-Bar for indexing to Alta or TotalRT All in One



See page 144 for additional Wing Board options.

kVue™ Access 360 G2 Prone Breast Insert

NEAR 360 DEGREE TREATMENT ACCESS

Designed to allow breast cancer treatment for both left and right breast, including whole breast, partial breast and accelerated breast treatments. The sleek, cantilevered design provides both oblique and non-coplanar access, potentially enabling higher dose per fraction. Since the beam path is primarily through the breast with minimal couchtop interference, artifacts and scattering may be minimized.



EXPANDED SUPRACLAVICULAR ACCESS

The thinner, wider grid window provides full access to treat the supraclavicular nodes. The supraclavicular access allows patient treatment in one setup if desired.



kVue Access 360 G2 Package

- RT-4544KV-10 Includes Left & Right Inserts, Prone Headrest, Contour Headrest, 2 Hand Grip Posts, Dual Hand Grip, CT Risers, CT Shims, Storage Cart
- RT-4544KV-13 Access 360 G2 Treatment Room Extender Package (without CT Risers and Shims)

See page 166 for Prone Breast VacQfix Cushions



Left & Right Inserts Prone Headrest Contour Headrest 2 Hand Grip Posts Dual Hand Grip CT risers and 2 CT shims Storage Cart

Features & Benefits of kVue Access 360 G2

CT SIMULATION

- 130 mm CT risers index to existing overlays with 2-pin locating bars
- 25 mm CT shims attach to the CT risers to raise the insert
- Rigid, lightweight CT risers are coated for easy cleaning

ALIGNMENT

- Virtual Indexing provides confirmation of patient alignment
- Ipsilateral scale provides an additional point of reference for laser alignment
- Knee alignment marks aid in patient positioning for daily setup

SUPRACLAVICULAR ACCESS

- Thin, wide-grid window provides full access for treatment of the supraclavicular nodes. (Exclusively available on the kVue Access 360 G2)
- Treatment of breast and supraclavicular nodes can be accomplished in one setup

OPEN ACCESS TREATMENT

- Breast cutout offers ability to treat with non-coplanar and oblique angles

ADDITIONAL ATTRIBUTES

- Inverted wing design flattens the back to position breast tissue away from chest wall and torso
- Ergonomic Dual Hand Grip relieves stress on patient's wrist
- Hand Grip Posts provide a hand hold for patients with limited mobility
- Prone headrest design allows free breathing while lateral light slots promote an open feeling for claustrophobic or anxious patients
- Contour headrest allows the patient's head to be rotated to either side

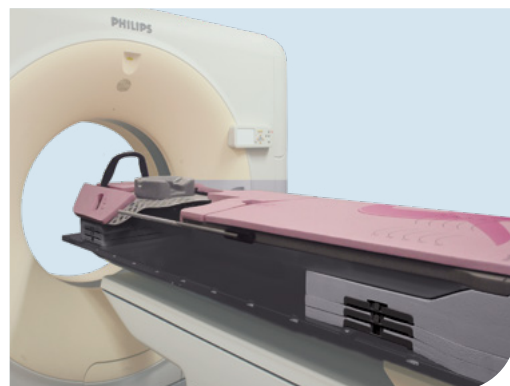

CT Simulation



Ipsilateral Scale

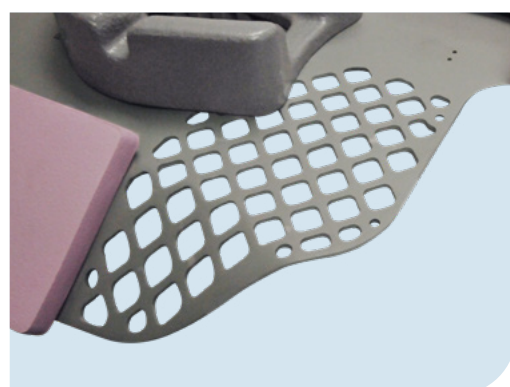

Supraclavicular Access

Access Prone G2 Breast Device

MR Safe and CT compatible to guide patients seamlessly from simulation through treatment. The lightweight construction of the Access Prone G2 makes it easy to set up. Foam padding increases patient comfort and a removable insert can be positioned for either left or right breast treatment. The easily interchangeable inserts provide flexibility to quickly change setups for treatment. These low-attenuating inserts have superior dosimetric profiles, which minimize skin reactions.

Length: 2125 mm (83.66")

RT-4544-01 Includes Prone Headrest, Contour Headrest, Left & Right Inserts, 2 Hand Grip Posts, Dual Hand Grip, CT Risers, 2 Sets of Shims, Storage Compartment



ACCESS PRONE G2 ACCESSORIES



Prone Headrest

Contour Headrest

2 Hand Grip Posts

Dual Hand Grip

Convenient Storage Compartment

Left & Right Breast Inserts

2 Sets of Shims



See page 166 for Prone Breast VacQfix Cushions

Features & Benefits of Access Prone G2

MR & CT SIMULATION

- Device allows seamless transition from simulation through treatment
- Incremental 25 mm shims allow variable height for patient setups

ALIGNMENT

- Ipsilateral scale provides an additional point of reference for laser alignment
- Knee alignment marks aid in daily patient setup

OPEN ACCESS TREATMENT

- Breast cutout allows treatment with non-coplanar and oblique angles

ADDITIONAL ATTRIBUTES

- Designed for patient comfort
- Internal hand grip accessory compartments for easy, convenient storage
- Easy setup for workflow efficiency
- Prone headrest promotes free breathing
- Contour headrest allows the patient's head to be rotated to either side
- Inverted wing design flattens the back to position breast tissue away from chest wall and torso



Convenient Storage Compartment

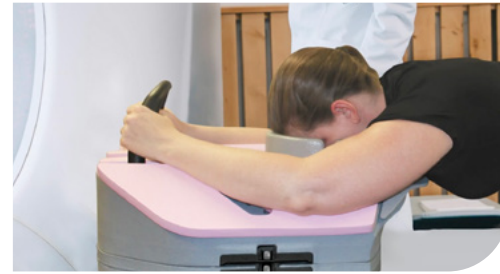

CT Simulation



Shims



Ipsilateral Scale



Knee Alignment Marks

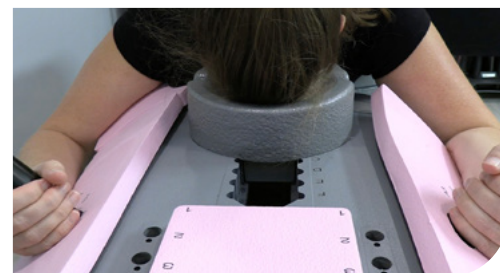

Inverted Wing Design

New Horizon™ Prone Breastboard

The New Horizon Prone Breastboard assists in providing accessible, comfortable, and reproducible patient positioning for prone breast treatments. The modular design and variety of accessories provide options for many prone breast setup challenges, allowing customized patient setups and meeting clinical needs for treatment.

- Solid and open contralateral wedges provided to meet individual patient needs
- Patient-friendly design, with contoured foam and an adjustable massage-style face cushion
- Indexable to the couchtop, assuring its orientation to lasers and isocenter is repeatable and known
- Scale rulers allow for easy verification of the longitudinal and lateral position of the patient
- Overall height can be adjusted through the use of 3 cm spacers
- Reversible breast section allows for treatment of either breast with a simple 180° turn
- Three simple-to-separate parts allow for a lighter board and easier storage and transport between treatment rooms
- The unique curved board rises to meet the patient halfway for less climbing and safe positioning



MTHPBB01	New Horizon
MTHPBB103	Head Cushion Covers, Qty 50

Thorawedge™

The Thorawedge is a unique positioning device allowing the patient to incline at multiple fixed angles, creating a comfortable position during diagnostic procedures.

The Thorawedge was co-developed with the Department of Radiotherapy of the University Medical Center in Utrecht, The Netherlands.

- Consists of two wedges (5° and 10°) and a comfortable arm support
- Wedges can be used separately or combined to reach a 15° angle. Additional 5° wedges can be added to form 20° and 25° angles
- Headrest and lumbar support can be indexed, assuring a reproducible patient position throughout the course of treatment
- Large side cut-outs allow for a full range of treatment angles
- Thorawedge locator allows quick indexing of the device to the couchtop in combination with a Lok-Bar

301080	Thorawedge
301081	Additional 5° Wedge
301082	Additional 10° Wedge
TW1100	Thorawedge Locator



Thorawedge Locator

Wing Boards™

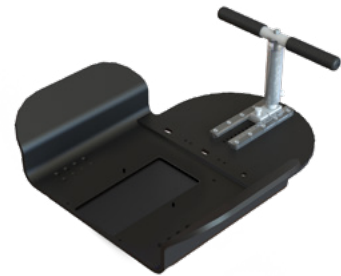

Extended Wing Board

The Extended Wing Board is 22.5" (57 cm) wide, constructed of durable, lightweight ABS and can be used with a T- or U-Grip handle. Its extended length allows for additional arm positioning flexibility. It is CT and MR Safe and indexable for enhanced reproducibility from imaging through treatment. It easily attaches to the Evolve breastboard.

MTWB08T	w/ T-Grip (shown)
MTWB08U	w/ U-Grip



Standard Wing Board

The Standard Wing Board is 22.5" (57 cm) wide, constructed of durable, lightweight ABS and features Delrin post hand grips. It is CT and MR Safe and indexable for enhanced reproducibility from imaging through treatment. It easily attaches to the Evolve breastboard.

MTWB09	
---------------	--

Grip Options

Both the T-Grip and the U-Grip are available individually. Compatible with the Extended and Tapered Wing Boards.



MTGBSUB1	T-Grip
MTGBSUB3	U-Grip



See page 131 for the Monarch Overhead Arm Positioner

See page 134 for the ArmShuttle Elite

See page 138 for the Pro Wing Board

See pages 117-121 for compatible headrest options

Treatment Brassiere

The Treatment Brassiere reshapes the ipsilateral breast more favorably for radiation treatments while moving the contralateral breast away from the beam. A complete library of 40 brassiere cups is available, with or without a portable storage caddy. Also available individually or in sets of five.

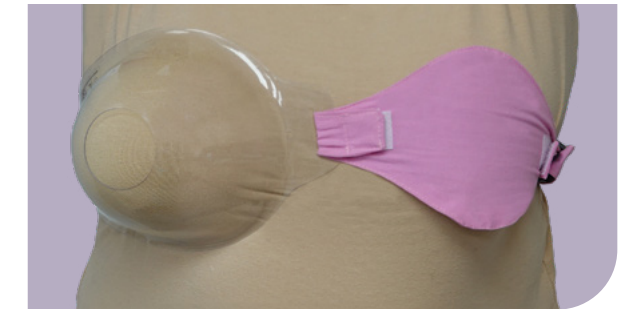

Brassiere Cups

Treatment Brassieres are available for both the left and right breast. Intermediate volumes can be accommodated because the anterior portions of cups are cut off and tissues near the apex protrude. See chart below for sizing. Left and right cups are not interchangeable.

Individual cups can be ordered by using the group number plus the volume number.
Example: MTBR100LL500

CLOTHING CUP SIZE	OBSERVED VOLUME (ML)
A	94 - 225
B	146 - 458
C	267 - 835
D	499 - 1120
DD	988 - 1427+
DDD	2756 - 3176

	LEFT GROUP	RIGHT GROUP	CUP VOLUME (ML) INCLUDED														
			200	250	300	400	500	600	750	1000	1250	1500	2000	2500	3000		
S	MTBR100SL	MTBR100SR	•		•	•	•	•									
M	MTBR100ML	MTBR100MR		•			•	•	•	•							
L	MTBR100LL	MTBR100LR					•	•	•	•	•						
XL	MTBR100XLL	MTBR100XLR								•	•	•	•	•	•	•	•
40 Cup Brassiere Library w/ Caddy MTBR100TBC			•	•	•	•	•	•	•	•	•	•	•	•	•	•	•

ALL PRODUCTS NOT CE MARKED

Hip, Pelvis, & Extremities



148-149
THERMIFIX & HIPFIX
IMMOBILIZATION SYSTEMS



150-151
ALTA PELVIS
THERMOPLASTIC



152
FLEXLOCK KNEE &
FOOT SUPPORTS

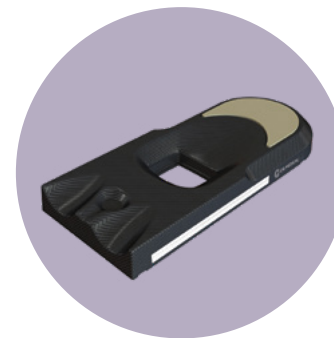

153 & 156
BELLYBOARDS

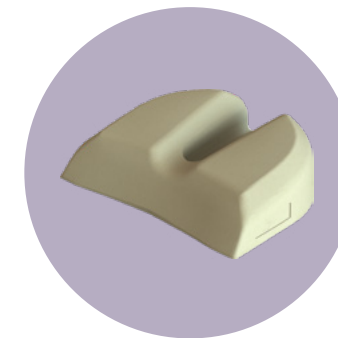

154-155
POSITIONING CUSHIONS

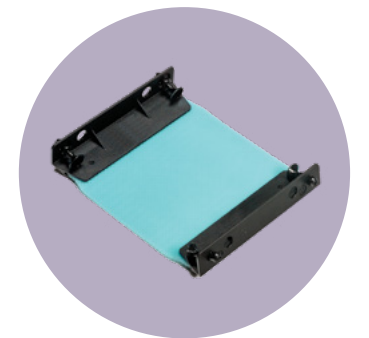

157
MULTIFIX



158
ENDORECTAL BALLOON

ThermFix™ Immobilization System

The ThermFix Immobilization System uses a single sheet of thermoplastic that forms over the breast, thorax, abdomen, hip, or pelvis to aid patient positioning and reproducibility. The ThermFix Bars easily attach and index to the TotalRT All in One Platform or Universal Couchtop and provide 1 cm indexing.

- Bar design provides a larger and more homogenous treatment area compared to a baseplate
- Multiple length and width indexing options accommodate many patient sizes
- Allows supine or prone positioning
- The inferior bar can be removed during patient load/unload to provide safer transitions
- Vac-Lok, RediFoam Cushions, and Wing Boards can be integrated for added comfort and support
- MR Safe, CT, and treatment compatible

ThermFix Base Package

Includes: Superior Bar, Inferior Bar, Spacing Tool (for breast, thorax, abdomen, hip and pelvic treatment with no central docking)

THRMTX100



ThermFix Pelvic Package

Includes: Superior Bar, Hip & Pelvic Bar, Spacing Tool (for hip and pelvic treatment with central docking)

THRMTX101



ThermFix Complete Package

Includes: Superior Bar, Inferior Bar, Hip & Pelvic Bar, Spacing Tool

THRMTX102



HipFix® Immobilization System

The HipFix hip and pelvis immobilization system utilizes a single sheet of thermoplastic over the entire abdomen and pelvis region, providing immobilization for fixed fiducial targeting. The versatile system accommodates both prone and supine patient setups.

- Indexable baseplate features a cutout treatment window
- Vac-Lok or RediFoam Cushion can be integrated for added comfort, support, and repositioning accuracy
- MR Safe, CT, and treatment compatible

MTPLVCO4MR HipFix Baseplate

MTVL71FC Split-Leg Vac-Lok (see page 163)

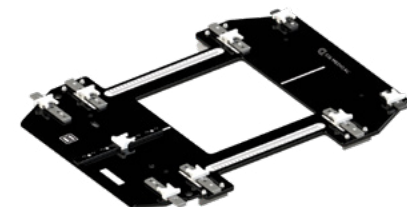
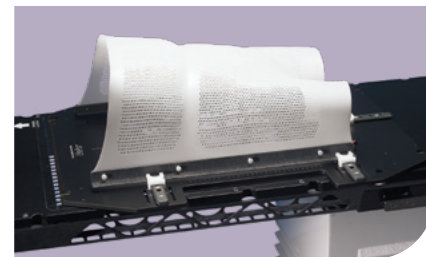

ThermFix & HipFix Thermoplastics

Thermoplastics are 18" x 22" (45.7 cm x 55.8 cm) and available with reloadable or disposable handles with solid, standard perforated or IMRT Reinforced perforation styles. The handles and groin piece secure to the device, providing an indexable setup.

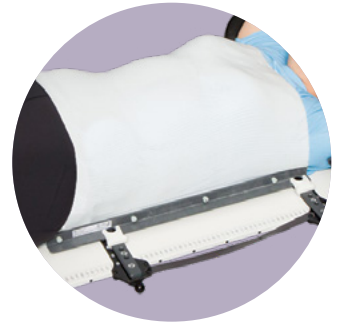

MTPLHA01 Reloadable Handles (x2) & Groin Piece

MTPLVCSUB8 Reusable Groin Piece for Hip Fix Thermoplastic

PERFORATION	HANDLE TYPE	THICKNESS	PART #	QTY	MATERIAL TYPE
Solid	Reloadable	3.2 mm	MTHFX1822S	5	Aquaplast RT
Solid	Reloadable	2.4 mm	MTHFX18222.4S	5	Aquaplast RT
Solid	Disposable*	3.2 mm	MTPLHA0201	5	Aquaplast RT
Perforated	Reloadable	3.2 mm	MTHFX1822	5	Aquaplast RT
Perforated	Reloadable	2.4 mm	MTHFX18222.4	5	Aquaplast RT
Perforated	Disposable*	3.2 mm	MTPLHA0202	5	Aquaplast RT
IMRT Reinforced	Reloadable	3.2 mm	MTHFI1822	5	Aquaplast RT
IMRT Reinforced	Reloadable	2.4 mm	MTHFI18222.4	5	Aquaplast RT
IMRT Reinforced	Disposable*	3.2 mm	MTPLHAI0203	5	Aquaplast RT
Perforated	Reloadable	3.2 mm	RT-1882KP	5	Fibreplast
Solid	Reloadable	3.2 mm	RT-1821KP	10	Fibreplast
Perforated	Reloadable	3.2 mm	RT-1882P	5	Aquaplast RT
Solid	Reloadable	3.2 mm	RT-1821P	10	Aquaplast RT

*Groin piece sold separately
All disposable thermoplastics are MRI compatible

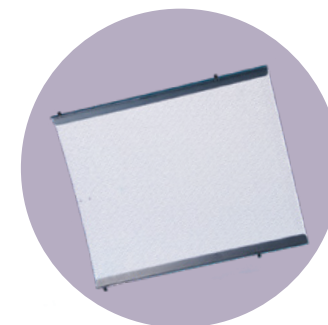

Standard Perforated Thermoplastic



IMRT Reinforced Thermoplastic

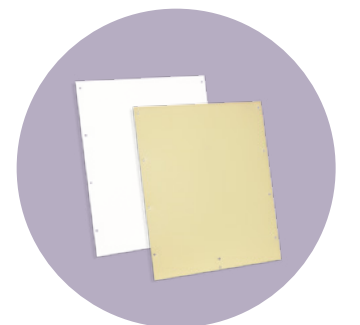

Reloadable Precuts

Alta Multipurpose Device for Pelvis

Alta allows positioning and immobilization of patients for pelvic applications through the use of pelvis thermoplastics and other pelvic positioning products. FlexLock accessories can be used to increase patient comfort and make fine positioning adjustments.

RT-4800-01	Alta Multipurpose Device
RT-4800-GL	Alta Groin Lock
RT-4800-H30	Alta Opti-Handles, 300 mm, set of 2
RT-4800-H45	Alta Opti-Handles, 450 mm, set of 2



Alta Groin Lock



Alta Opti-Handles, 450 mm

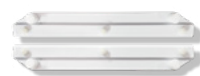

Alta Opti-Handles, 300 mm

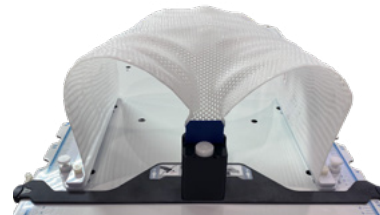

Alta Groin Lock shown with Pelvis Thermoplastic and Alta Opti-Handles

Aquaplast RT Aqua-Brief

The pelvis thermoplastic series is compatible with the Alta Multipurpose Device and the Carbon Fiber Pelvis System. These thermoplastics allow for the immobilization of the pelvis region. The system flattens the lower lumbar for added comfort and repeatability. Aquaplast RT is available in 2.4 mm and 3.2 mm thickness. See page for 151 thermoplastic options.

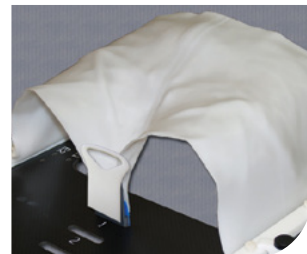

The Aqua-Brief technique uses a sheet of Aquaplast RT and a three-point fixation system covering the pelvis region and not the abdomen. The Groin Lock Key provides a secure, indexable patient fixation.

Aquaplast RT Aqua-Brief Thermoplastic

FOR USE WITH ALTA MULTIPURPOSE DEVICE & CARBON FIBER PELVIS SYSTEM

Compatible with 300 mm Opti-Handles

RT-1848	Aquaplast RT, 300 mm x 600 mm x 3.2 mm (12 in x 24 in), Solid with bonded Groin Lock (pre-punched for 300 mm handles)
RT-1883P12A	Aquaplast RT, 300 mm x 450 mm x 3.2 mm (12 in x 18 in), Standard Perf with bonded Groin Lock (pre-punched for 300 mm handles)
RT-1823P12A	Aquaplast RT, 300 mm x 450 mm x 3.2 mm (12 in x 18 in), Solid with bonded Groin Lock (pre-punched for 300 mm handles)

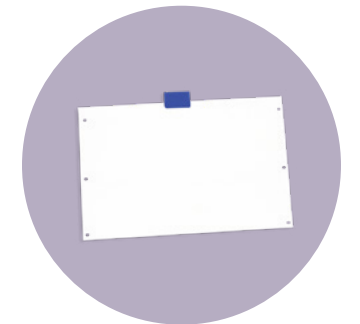

Opti-Handles

Compatible with 450 mm Opti-Handles

RT-1882P18A	Aquaplast RT, 450 mm x 600 mm x 3.2 mm (18 in x 24 in), Standard Perf with bonded Groin Lock (pre-punched for 450 mm handles)
RT-1822P18A	Aquaplast RT, 450 mm x 600 mm x 3.2 mm (18 in x 24 in), Solid with bonded Groin Lock (pre-punched for 450 mm handles)

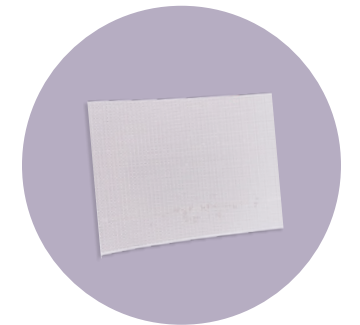

Opti-Handles without Groin Lock

Compatible with 300 mm Opti-Handles, without Groin Lock

RT-1783P3	Aquaplast RT, 300 mm x 450 mm x 2.4 mm (12 in. x 18 in.), Standard Perf
-----------	---

FOR USE WITH OTHER SYSTEMS

Pelvis Precut for ORF 4-Point System

RT-1882ORFPLV4	Aquaplast RT Pelvis Precut with pre-bonded disposable handles for ORF 4-point system, 3.2 mm, Standard Perf
----------------	---

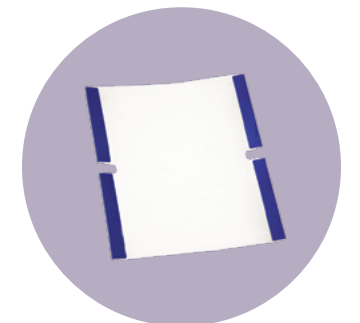

Pelvis Precut for ORF 4-Point System

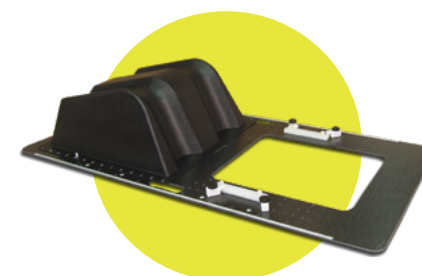

CONTACT SALES FOR CARBON FIBER PELVIS SYSTEM ORDERING INFORMATION

FlexLock™ Knee & Foot Supports

REPRODUCIBLE POSITIONING & PATIENT COMFORT

The FlexLock supports offer customizable indexing options for positioning the lower abdomen, pelvis, and lower extremities. The knee support allows for precise superior-to-inferior adjustments while the patient is in position, features integrated height adjustability, and is easy to clean. Additionally, the foot support can be angled for patient comfort.

- Ergonomically designed for patient comfort while maintaining reproducible positioning
- Optional clip-on leg and foot straps for added immobilization
- Highly durable and cleanable



RT-4800-FS	FlexLock Foot Support
RT-4800-KS	FlexLock Knee Support
RT-4489STRAP	Leg & Foot Strap Assembly, Set of 2

Shoulder Retractor Strap

Designed to pull the shoulders down during simulation and treatment, this accessory is compatible with FlexLock and SofTouch Knee and Foot Supports.

RT-4800-SR	Shoulder Retractor Strap
------------	--------------------------

Combifix™ 3 and Feetfix Couch Support

The Combifix 3 combines the Kneefix and Feetfix, providing enhanced positioning for the pelvic region and other lower extremities.

The Feetfix Couch Support may be used separately and positions the Feetfix at indexed positions, allowing the Feetfix to be tilted at four different angles. Both the Combifix & Feetfix are two- and three-pin Lok-Bar indexable.

Shoulder retractors are available to pull the shoulders down during radiotherapy simulation and treatment sessions where opposed lateral fields are used in the neck area. They can attach in five positions on the Feetfix.

151004MR	Includes Combifix Baseplate, Kneefix 3, Elevation Blocks (x2), Feetfix 3 & Feetfix Couch Support
151005MR	Includes Combifix Baseplate, Low Kneefix 2 Cushion, Elevation Blocks (x2), Feetfix 3 & Feetfix Couch Support
302071MR	Feetfix Couch Support Bracket (Cushion not included)
302072	Shoulder Retractors: Short (x2) and Long (x2)

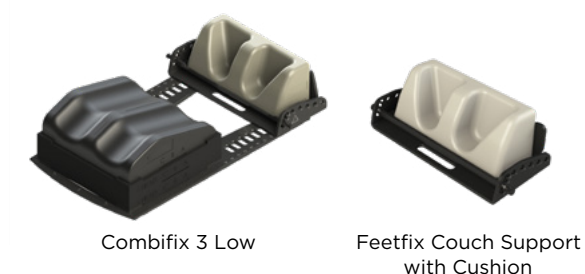

Carbon Fiber & MRSeries Bellyboards

The Carbon Fiber Bellyboard assists in reducing the volume of the small bowel that is irradiated in patients undergoing treatment in the pelvic region. The contoured opening allows for displacement of the small bowel, as the central support structure assists in compressing the small bowel forward into the opening.

- Carbon Fiber model features embedded fiducial crosshair to assist as a secondary setup reference
- Lightweight, rigid and indexable
- Lower part of board is adapted to support the patient's upper legs for maximum comfort
- Soft polyethylene padding ensures a comfortable position for the head
- Optional Prone Thorax Support cushion (see page 154)

125012	Carbon Fiber Bellyboard
126000	MRSeries Bellyboard
013140	Bellyboard Wall Storage (see page 225)



Caudal Indentation [1] to relieve pressure in the genital area. Central Space [2] allows compression to push the small bowel superior toward the Major Aperture [3].

Prone Positioning Cushions

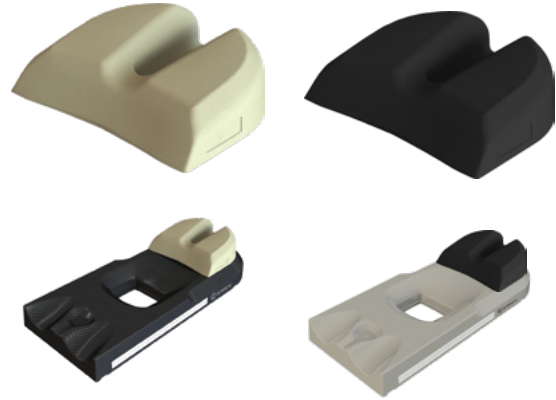

Prone Thorax Support

The Prone Thorax Support is designed to relieve chest compression during treatments in the prone position. It can be used as a stand-alone patient support or as an option on the Bellyboard to allow large patients to be treated in the prone position.

301076	Cream
301102	Black



Prone-Lok™ Cushion

The Prone-Lok Positioning Cushion enhances patient comfort through its specially designed foam construction. Its contoured corners eliminate shoulder impingement. The center portal opens the patient's field of view, improving patient comfort. The cushion is indexable and can be easily cleaned and reused.

MTPLC01



Pron-Pillo™ Cushion

The Pron-Pillo provides comfort and stability for patients in the prone position. The cushion can be easily cleaned and reused.

MTCB36

Kneefix™ 3 & Feetfix™ 3 Cushions



Kneefix Indexing Holes

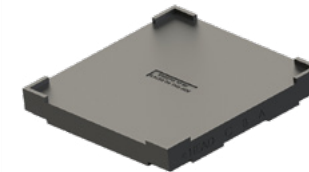

Kneefix 3

The Kneefix 3 cushion contributes to better stability and reproducibility in the supine position, regardless of the target area. It promotes patient comfort and is therefore ideal for use during lengthy procedures on rigid surfaces. The Kneefix 3 is 16 cm tall and is made of lightweight, closed cell foam that is easy to clean and is both two- and three-pin indexable. A Low Kneefix 2 (12 cm) is available for additional setup.

301052	Kneefix 3 (Cream)
301048	Low Kneefix 2 (Black)

Kneefix 3 Elevation Blocks

The Kneefix 3 Elevation Blocks can elevate the Kneefix 3 by 5 cm. The Kneefix fits in the topside of the elevation block and will not slide off. Elevation Blocks may be stacked to raise the legs even higher. The Kneefix 3 Elevation Blocks are both two- and three-pin indexable.

301055	Qty 1
301056	Qty 3

Feetfix 3

The Feetfix 3 is a universal patient support cushion for radiotherapy and diagnostic procedures and has been designed to provide comfortable positioning with enhanced immobilization. The Feetfix 3 is 16 cm tall and is made of lightweight, closed cell foam that is easy to clean. It can be used with either a two- or three-pin indexable Lok-Bar or with the Feetfix Couch Support (page 153).

301071	Feetfix 3 (Cream)
--------	-------------------

SofTouch™ Elite Bellyboard

The SofTouch Elite Bellyboard is an adjustable stabilization platform designed to position the lower bowel away from the treatment field during prostate radiotherapy. It features a removable caudal cushion and separate belly support cushions for a customized patient setup. The bellyboard, made from unique semi-firm radiolucent foam, provides repeatable positioning and is contoured to relieve pressure points, enhancing patient comfort. Multiple cushion configurations allow for optimal anatomical placement of both external and internal anatomy, leading to improved clinical outcomes.

- Three contoured and adjustable headrests allow for improved patient comfort
- Provides multiple indexing locations to ensure precise, repeatable positioning
- Ergonomic hand grip relieves stress on patient's wrists
- Removable cushions allow for custom patient setup
- Contoured to relieve pressure point stress
- Scales to aid in laser alignment
- Includes wall hook for convenient storage solution
- Lightweight, easy to clean and MRSafe



Wall Hook (fasteners not included)

15 mm headrest

RT-4464-02 SofTouch Elite Bellyboard



The Bellyboard system comes with a prone headrest that can be indexed in multiple locations.

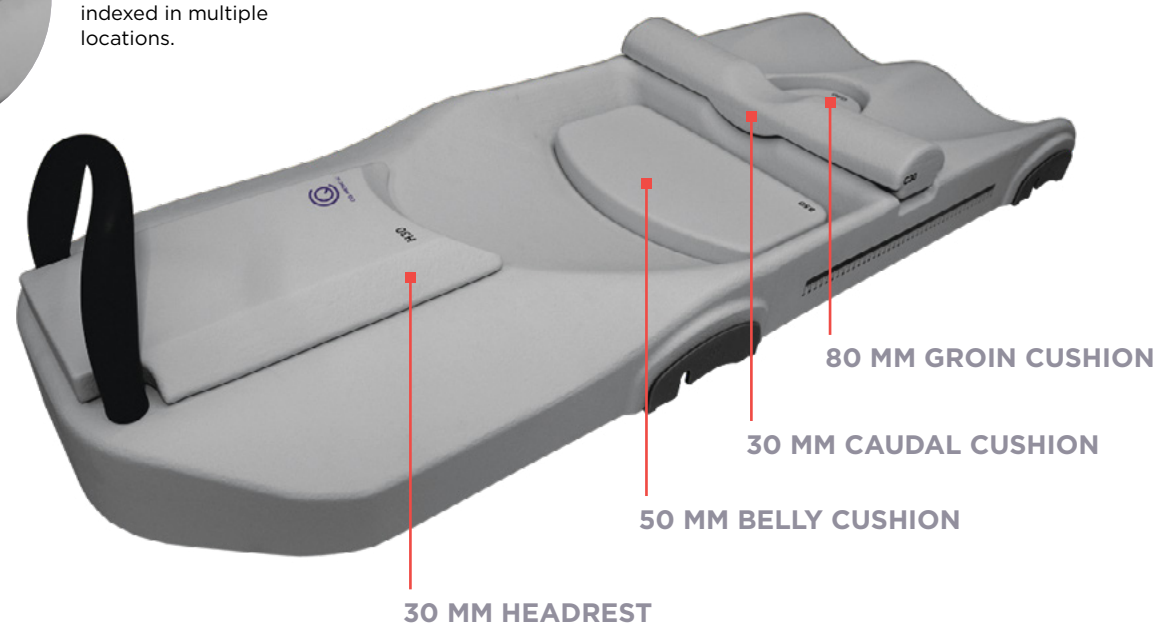

Dual Leg Positioner

The Dual Leg Positioner quickly captures the lower legs for supine hip and pelvic treatments. It holds the legs at the same level, reducing pelvic rotation. An optional Velcro® strap secures the calves and ankles. The positioner is indexable for enhanced reproducibility and can be easily cleaned and reused.

MTDLI2 Standard (76 x 46 x 19 cm) (top photo)

MTDLIZ2 Low (76 x 46 x 11 cm) (bottom photo)

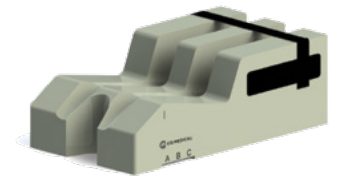

MultiFix™

The Multifix is a versatile system designed to secure arms and legs in straight or bent positions using small Posicast precuts. These precuts can be easily molded to fit anatomical contours and are then attached to the baseplate at clearly marked positions. The indexable baseplate ensures a reproducible setup, with four sets of indexing holes providing an isocentric position for the treated extremity, regardless of its placement on the Multifix.

107063 Multifix Baseplate, Carbon Fiber

930080 Small Multifix Posicast-Plus Microperfo Thermoplastic



RectalPro™ 75 Endorectal Balloon (ERB)

The curved shaft design of the RectalPro enhances patient comfort. The air/water fill volume is adjustable to meet clinical needs, ensuring reproducible balloon positioning. Overall, it minimizes prostate movement during treatment and allows for consistent positioning.

- Reduces ano-rectal toxicity
- Increases gland stability
- Improved daily reproducibility
- Promotes rectal wall and sphincter sparing
- Reduces intra-fraction prostate motion

RT-4415RP-50 RectalPro 75 Endorectal Balloon
(Quantity 50 with 100 ml Syringe)

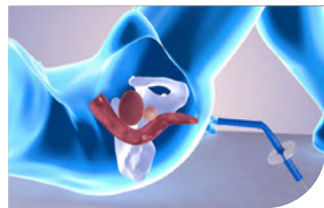

Insert the ERB tip towards the table/couch and follow the anatomical curve of the colon

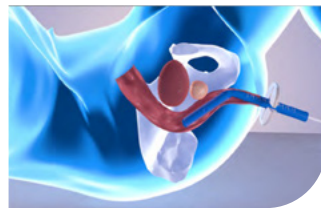

ERB inserted

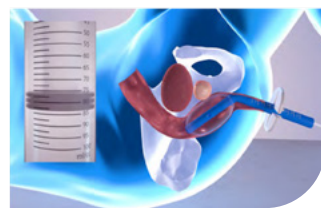

Slowly inflate with air/water 60-100 ml with physician's directions

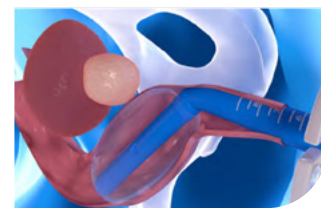

After inflation, pull down the ERB and affix the stopper

Vacuum & Positioning Cushions



Vac-Lok™ Cushions

Vac-Lok Cushions create a rigid and secure support around the patient when a vacuum is drawn through a self-sealing quick-release valve. These cushions retain their shape and guarantee stability and reproducibility of the patient's position for up to six weeks once the air is vacuumed out.

- More rigid than previous generation (cream) bags
- Protective material coating provides greater cleanability than previous generation bags
- Attached indexing battens (on specific sizes) provide an easy method for repositioning
- Available for a span of clinical setups including head & neck, breast, pelvic & hip, and full body
- Treatment area is artifact-free with minimal beam attenuation
- Reusable for ultimate cost-effectiveness
- Available in gray nylon or clear urethane
- Cleared for use in proton therapy



Indexing battens provide an easy method for repositioning Vac-Lok Cushions



Self-sealing quick-release valve

Rectangular Vac-Lok Cushions

DIMENSIONS	FILL	URETHANE	NYLON	NYLON W/ INDEXING
25 x 50 cm	2.25 L	VLE225	VLE225C	-
50 x 70 cm	15 L	VL15	VL15C	VL15FC
70 x 70 cm	20 L	VLJ20	VLJ20C	VLJ20FC
70 x 100 cm	26 L	-	VLG26C	VLG26FC
70 x 100 cm	35 L	VLG35	VLG35C	VLG35FC
70 x 100 cm	40 L	VLG40	VLG40C	VLG40FC
75 x 100 cm	21 L	-	VLPLV09C	VLPLV09FC
75 x 100 cm	28 L	VLPLV01	VLPLV01C	VLPLV01FC
75 x 120 cm	34 L	VLPLV02	VLPLV02C	VLPLV02FC
75 x 120 cm	25 L	-	VLPLV10C	VLPLV10FC
75 x 150 cm	50 L	VLFB01	VLFB01C	VLFB01FC
75 x 180 cm	62 L	-	-	VLFB02FC
100 x 100 cm	40 L	VLB40	VLB40C	-
100 x 150 cm	80 L	-	VLA80C*	-
100 x 200 cm	90 L	-	VLH90C*	-

*Some Vac-Lok Cushions require longer lead time. Please ask your sales representative for lead times.

Non-Rectangular Vac-Lok Cushions

CUSHION	DIMENSIONS	FILL	URETHANE	NYLON	NYLON W/ INDEXING	PHOTO PAGE
Head & Shoulders "T"	50 x 70 cm	6 L	VL37	-	-	163
"T"	87.5 x 140 cm	25 L	-	VL14C25*	-	-
"T" Tapered Mid-section	108 x 125 cm	44 L	-	-	VL0017	162
"T" Non-Tapered Mid-section	108 x 125 cm	42 L	-	-	VL0018	162
"T" Tapered Mid-section w/ Handle Cutout	108 x 125 cm	31 L	-	-	VL0022	-
Type-S	61 x 65 cm	8 L	-	-	VLTY01CX	163
Type-S	140 x 65 cm	27 L	-	-	VLTY02CX	163
Arms Up	75 x 75 cm	20 L	VLARM01	VLARM01C	VLARM01FC*	162
Arms Up	105 x 75 cm	28 L	-	VLARM02C	VLARM02FC	162
One Arm Up	100 x 80 cm	34 L	-	VL04C	-	162
Wing Board	88 x 55 cm	15 L	VLWGB03	VLWGB03C	-	162
Monarch Wing Board	108 x 55 cm	17 L	-	VLWGB04C	-	162
Monarch Wing Board w/ Head Support Cutout	108 x 55 cm	14 L	-	VLWGB05C	-	162
Split Leg	60 x 100 cm	15 L	-	-	VL71FC	163

*Some Vac-Lok Cushions require longer lead time. Please ask your sales representative for lead times.



75 x 120 cm (Rectangular Cushion)



105 x 75 cm (Arms Up Cushion)



108 x 55 cm (Monarch Wing Board Vac-Lok)



108 x 125 cm (T-Shape Cushion w/ Tapered mid-section)

Breast & Thorax Vac-Lok Cushions

Vac-Lok cushions create a rigid and secure support around the patient when a vacuum is drawn through a self-sealing quick-release valve. Cushions are available in two durable finishes: nylon and urethane. Nylon cushions can be ordered with indexing bars attached. Cleared for use in proton therapy.



Arms Up Vac-Lok, 105 cm long, 28 L Fill

VLARM02C	Nylon
VLARM02FC	Nylon w/ indexing



Arms Up Vac-Lok, 75 cm long, 20 L Fill

VLARM01	Urethane
VLARM01C	Nylon
VLARM01FC*	Nylon w/ indexing



Wing Board Vac-Lok, 88 x 55 cm, 15 L Fill

VLWGB03	Urethane
VLWGB03C	Nylon



Monarch Wing Board Vac-Lok, 108 x 55 cm

VLWGB04C	Nylon, 17 L Fill
VLWGB05C	Nylon w/ Head Support Cutout, 14 L Fill



T-Shape Vac-Lok, 108 x 125 cm

VL0017	Nylon w/ indexing, Tapered mid-section, 44 L Fill
VL0018	Nylon w/ indexing, Non-tapered mid-section, 42 L Fill
VL0022	Nylon w/ indexing, Tapered mid-section and Handle Cut Out, 31 L Fill



One Arm Up Vac-Lok, 34 L Fill

VL04C	Nylon
-------	-------

*Some Vac-Lok Cushions require longer lead time. Please ask your sales representative for lead times.

Head & Neck Vac-Lok Cushions



"T" Cushion

VL37	50 x 70 cm "T" Vac-Lok Cushion
------	--------------------------------

Type-S Cushion

VLTY01CX	Type-S Vac-Lok Cushion (short)
VLTY02CX	Type-S Vac-Lok Cushion (long)

Hip & Pelvic Vac-Lok Cushions



75 x 100 cm

VLPLV09C	Nylon, 21 L Fill
VLPLV09FC	Nylon w/ indexing, 21 L Fill
VLPLV01	Urethane, 28 L Fill
VLPLV01C	Nylon, 28 L Fill
VLPLV01FC	Nylon w/ indexing, 28 L Fill

75 x 120 cm

VLPLV10C	Nylon, 25 L Fill
VLPLV10FC	Nylon w/ indexing, 25 L Fill
VLPLV02	Urethane, 34 L Fill
VLPLV02C	Nylon, 34 L Fill
VLPLV02FC	Nylon w/ indexing, 34 L Fill

Split Leg Cushion

For use with the HipFix System (see page 148).

VL71FC	Nylon w/ indexing, 15 L Fill
--------	------------------------------

See pages 160 & 161 for more information on Vac-Lok cushions.

VacQfix™ Cushions

Custom formed for patient comfort and positioning accuracy, becoming rigid when vacuum is applied. They can be cleaned and reused after each course of treatment. Our fine denier fabric and small-diameter foam bead fill combine to increase conformity and reproducibility.



M Standard Valve

All VacQfix Cushions come with the M Standard Valve.



NYLON	DIMENSIONS	FILL	CUSHION	PHOTO PG
RT-4517-4079VF15M	40 x 80 cm	15 L	SBRT, thigh compression	-
RT-4517-5070F15M	50 x 70 cm	15 L	Extremities	165
RT-4517-7070F20M	70 x 70 cm	20 L	Upper body	165
RT-4517-T6565F7M	65 x 65 cm	7 L	Head & Shoulders (T-Shape)	165
RT-4517-T7993F20M	79 x 93 cm	20 L	Breastboard	165
RT-4517-10070F30M	70 x 100 cm	30 L	Multi-purpose use	-
RT-4517-10070F35M	70 x 100 cm	35 L	Multi-purpose use	165
RT-4517-10070F40M	70 x 100 cm	40 L	Multi-purpose use	-
RT-4517-100100F30M	100 x 100 cm	30 L	Multi-purpose use	-
RT-4517-100100TRAPF35M	100 x 100 cm	35 L	Trapezoid	166
RT-4517-100100F40M	100 x 100 cm	40 L	Upper body	-
RT-4517-80150F65M	80 x 150 cm	65 L	Hip or pelvis	166
RT-4517-12075F35M	75 x 120 cm	35 L	Multi-purpose use	166
RT-4517-PB3M	55 x 96 cm	12 L	Access prone with headrest cutout	166
RT-4517-PB4M	55 x 96 cm	15 L	Access prone without headrest cutout	166
RT-4517-100220F120M	100 x 220 cm	120 L	Full body	167
RT-4517-230120T80F90M	120 tapered to 80 x 230 cm	90 L	SBRT, whole body	167
RT-4517-0002M	120 tapered to 80 x 160 cm	90 L	2-Chamber	167
RT-4517-0003M	120 tapered to 80 x 230 cm	90 L	3-Chamber	167

Dimensions listed are approximate measurements for cushions with no fill. Dimensions are for reference only.

VacQfix Cushions



RT-4517-5070F15M	50 x 70 cm, 15 L Fill, for extremities
RT-4517-7070F20M	70 x 70 cm, 20 L Fill, for upper body
RT-4517-T6565F7M	65 x 65 cm, T-Shaped, 7 L Fill, for head & shoulders
RT-4517-T7993F20M	Breastboard Cushion, 79 x 93 cm, 20 L Fill
RT-4517-10070F35M	70 x 100 cm, 35 L Fill
RT-4517-100100F40M	100 x 100 cm, 40 L Fill, for upper body

Dimensions listed are approximate measurements for cushions with no fill. Dimensions are for reference only.

VacQfix Cushions



RT-4517-80150F65M 80 x 150 cm, 65 L Fill, for hip or pelvis

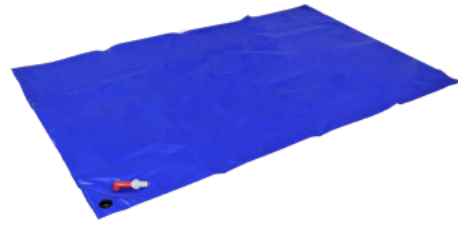

RT-4517-12075F35M 75 x 120 cm, 35 L Fill



RT-4517-100100TRAPF35M 100 x 100 cm, Trapezoid, 35 L Fill



RT-4517-PB3M Access Prone VacQfix Cushion with headrest cutout, 55 x 96 cm



RT-4517-PB4M Access Prone VacQfix Cushion without headrest cutout, 55 x 96 cm

RT-4544KV-IND Prone VacQfix Indexer



RT-4517-0002M 120 x 160 cm/80 cm, 2-Chamber

Dimensions listed are approximate measurements for cushions with no fill. Dimensions are for reference only.

VacQfix Cushions



RT-4517-0003M 120 x 230/80 cm, 3-Chamber



RT-4517-230120T80F90M 120 tapered to 80 x 230 cm, Whole Body SBRT, 90 L Fill



RT-4517-100220F120M 100 x 220 cm, 120 L Fill, full body

Dimensions listed are approximate measurements for cushions with no fill. Dimensions are for reference only.

Vac-Lok & VacQfix Accessories



Vac-Lok Cleaner

This spray is available for use on Vac-Lok cushions.
ONLY AVAILABLE IN THE U.S.

MTCBPFC



Helping Hands™

The Helping Hands Cushion Manager is designed to help handle large-size Vac-Lok cushions that tend to hang off the couch during the forming process.

MTVLHH150 150 cm long



I.D. Tags

Color-coded tags provide quick identification of patient cushions. Tags are available in assorted colors and include tie strings.

MTVLTAG Pack of 25 Tags, Assorted Colors



Storage Racks

This space-saving rack holds molded & inflated cushions. Plastic "S" hooks are available for hanging cushions.

MTVL401 Storage Rack, Double Wide

MTVL402 Casters for MTVL401, Qty 4

MTVLHOOK "S" Hooks, Qty 10

Vac-Lok & VacQfix Accessories



Slide Guide Lok-Bar

The Slide Guide Lok-Bar does not lock down to the indexing points along the couchtop but slides longitudinally along the couchtop. It is designed to prevent lateral movement and is useful for longer devices such as bellyboards, breastboards and Vac-Lok Cushions, which contract during forming.

MTVL00853

MTIL1006 Transverse

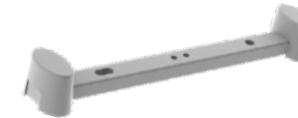

VacQfix Indexer

RT-4517-IND01



Prone VacQfix Indexer

RT-4544KV-IND

Vacuum Compressors

Dual Function Compressors

The Dual Function Vacuum Compressor, available in a 115V and 230V version, provides both a vacuum and inflate cycle with a convenient hand control or optional foot control. It provides an audible alarm when your optimum vacuum level is reached.



MTVP1	115V
MTVPEXA	230V, Europe
MTVPEXC	230V, Australia
MTVPEXD	230V, UK
MTVPEXG	230V, India
MTVPEXH	230V, Israel
MTVPFT	Foot Control (optional) (right photo)



VacQfix Standard Dual Mode Vacuum Pump, 220-volt

Vacuum Pumps

Vacuum Pumps are simple to use and allow you to mold firm, stable patient positioning cushions in minutes.

RT-PUMPQ1	VacQfix Standard Dual Mode Vacuum Pump, 110-volt, includes hose
RT-PUMP220Q1	VacQfix Standard Dual Mode Vacuum Pump, 220-volt, includes hose (left photo)
RT-PUMPQ-TS	Toggle Switch for Standard Dual Mode Pump
8003415	SingleStep Hose to M Standard Valve Adapter



Toggle Switch for Standard Dual Mode Pump



SingleStep Hose to M Standard Valve Adapter

Positioning Cushions

RediFoam™ Two-Part Positioning Foam

RediFoam two-part positioning foam is both CFC- and TDI-free. You can make setup marks directly onto RediFoam for verifiable repositioning throughout treatment.



MTFA39B	RediFoam, Small Includes 33 x 40" (83.8 x 101.6 cm) RediFoam bag
MTFA40B	RediFoam, Large Includes 39 x 46" (99.1 x 116.8 cm) RediFoam bag
MTFA41B	RediFoam, X-Large Includes 39 x 56" (99.1 x 142.2 cm) RediFoam bag

ONLY AVAILABLE IN THE U.S.

Multi-Purpose Support Cushions

Multi-Purpose Support Cushions are exclusive closed cell PE foam that will not stain or absorb liquids. They are more firm than regular, coated support cushions. Five different shapes are sold separately or as a complete set, which also includes a Hand/Finger Positioner.

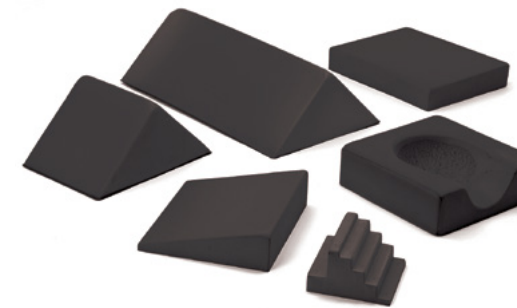

403024	Rectangle	30 x 24 x 5 cm
402422	15° Wedge	24 x 22 x 7 cm
402848	45° Wedge	28 x 48 x 14 cm
402820	45° Wedge	28 x 20 x 14 cm
402525	Head Support	25 x 25 x 8 cm
400006	Set of Six	-

NOTE: HAND/FINGER POSITIONER ONLY AVAILABLE IN SET OF SIX (400006)

Shoulder Support Cushion

The Shoulder Support Cushion is a wedge shaped cushion designed to support the shoulders and upper body of the patient. When placed over the Posifix-1 or -2 baseplate, the contours of the baseplate hold the cushion firmly in place.



301040	Shoulder Support Cushion
--------	--------------------------

Leg Roll Positioner

Quality foam cushions are durable for everyday use and will maintain consistent shape and patient comfort. Colors may vary.



RT-4474-6	60 x 15 cm (24 in x 6 in)
RT-4474-8	60 x 20 cm (24 in x 8 in)

Foam Positioners



These foam positioning aids are encased in blue vinyl fabric. They are designed for optimal durability and comfort and can easily be cleaned and reused.

MTVIPFFF101C 35°/55° Wedge 	MTVIPFFF102C 45° Wedge 	MTVIPFFF103C 15° Wedge 	MTVIPFFF104C 20° Wedge
MTVIPFFF203C 27° Wedge 	MTVIPFFF205C 45° Wedge 	MTVIPFFF301C Angled Bolster 	MTVIPFFF302C Angled Bolster
MTVIPFFF303C Knee/Back Bolster 	MTVIPFFF309C Bolster 	MTVIPFFF407C 45° Wedge 	MTVIPFFF502C Chest/Leg Wedge
MTVIPFFF704C Leg Immobilizer 			

MTVIPFFF801C	Rectangle	1 x 7 x 10" (2.5 x 17.8 x 25.4 cm)
MTVIPFFF802C	Rectangle	2 x 7 x 10" (5.1 x 17.8 x 25.4 cm)
MTVIPFFF105C	Rectangle	2 x 7 x 11" (5.1 x 17.8 x 27.9 cm)
MTVIPFFF803C	Rectangle	3 x 7 x 10" (7.6 x 17.8 x 25.4 cm)
MTVIPFFF804C	Rectangle	4 x 7 x 10" (10.2 x 17.8 x 25.4 cm)
MTVIPFFF106C	Circle	6" (15.2 cm)

THESE PRODUCTS HAVE NOT BEEN CE MARKED

CQ MEDICAL EDUCATION CENTER



The CQ Medical Education Center is designed to **simulate a clinical environment** and **facilitate educational webinars**. The center allows us to provide **uninterrupted support** to our clinical partners around the world.

One of the greatest benefits of an interactive, web-based session is the ability to showcase our positioning & immobilization solutions and treatment options. It helps us understand your current workflow so that we can **focus on the device and techniques that work best for you**.

We are excited to offer a live learning resource to our customers & partners!



VIEW OUR CE WEBINAR OPPORTUNITIES OR SCHEDULE A TRAINING COURSE

Fiducial Markers

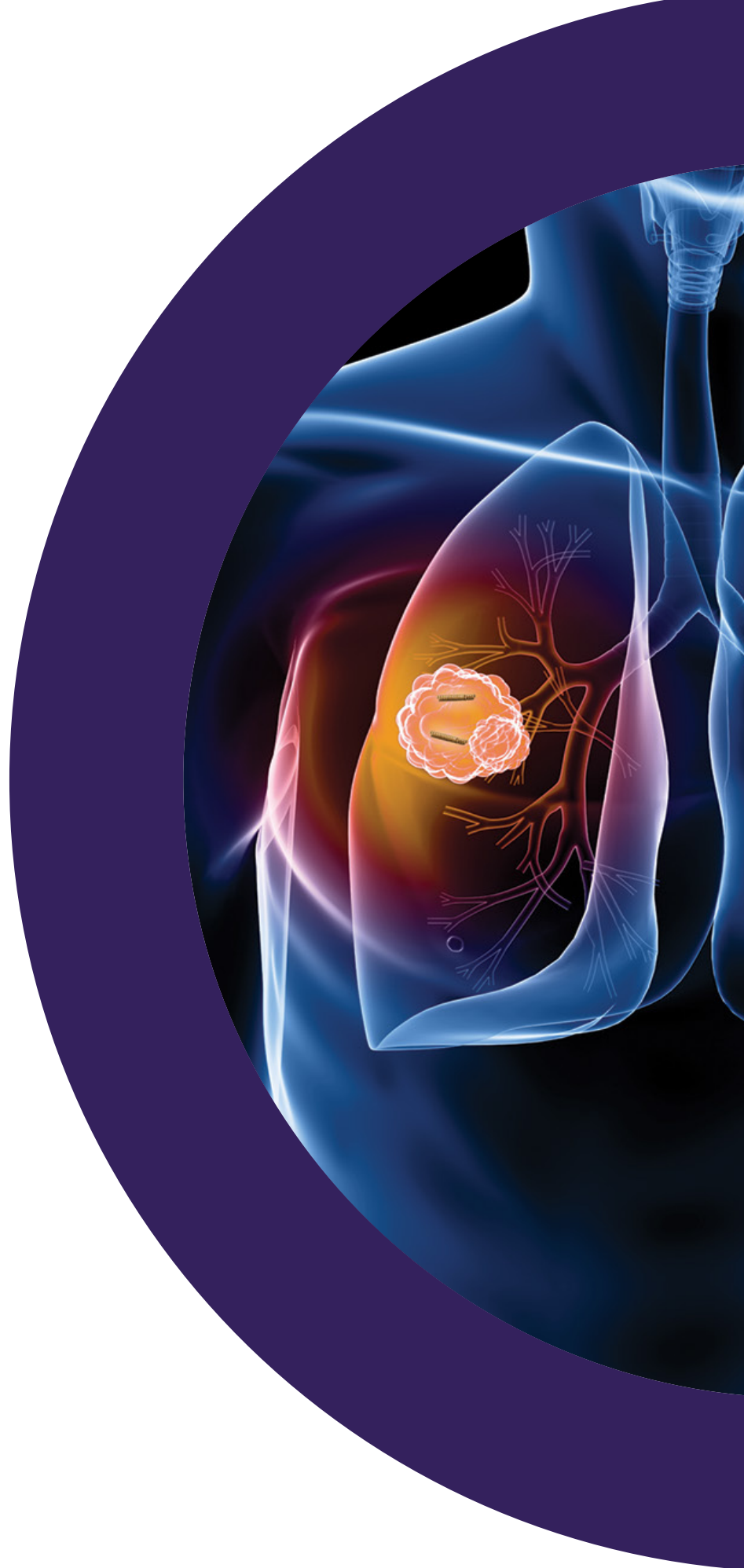

Fiducial Markers

DISEASE SITE RECOMMENDATIONS

 HEAD & NECK
  BREAST
  LUNG
  ABDOMEN
  PROSTATE

LARGEST SELECTION OF SPECIALLY DESIGNED FIDUCIALS INCLUDES

- Linear gold coils with solid identifiable end points
- Linear gold coils specific for MRI and CT fusion
- Biocompatible artifact free polymer markers
- Fiducials linked at a specific distance for precise localization
- Liquid fiducial unique for marking tissue

GOLD MARKER FEATURES

- Specially knurled surface is designed to inhibit migration
- 99.9% pure gold
- Non-biological imaging characteristics make markers easier to identify









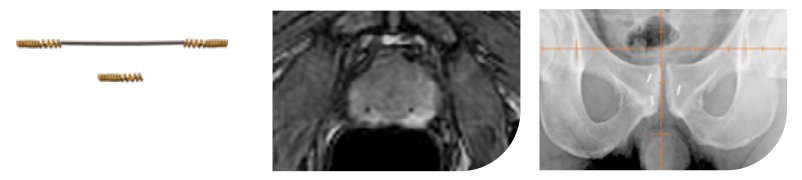



MULTIPLE NEEDLE GAUGE SIZES

- 20, 19, 18 and 17 gauge needles

FusionCoil™







The FusionCoil Marker images equally as well in CT as it does in MRI. It consists of an open spiral gold coil with a special biocompatible alloy core that appears as a solid black dot in MRI. This is the first of its kind, providing superior reference for image fusion as well as precise IGRT.



MTCTXFC1051820	1 x 5 mm marker	18 GA ETW x 20 cm needle	Qty 1	   
MTCTXFC10201820	1 x 20 mm marker	18 GA ETW x 20 cm needle	Qty 1	 
MTCTXFC10251820	1 x 5 mm marker	18 GA ETW x 20 cm needle	Qty 1	 
Includes 2 markers with a 15 mm bioabsorbable spacer. NOT CE MARKED				
MTCTXFC1051825	1 x 5 mm marker	18 GA ETW x 25 cm needle	Qty 1	   

FusionCoil SBRT Kit

Cartridge Kits reduce the number of needle passes and minimize the chance of Edema or Pneumothorax.

MTCTXFC001 NOT CE MARKED	Pre-loaded FusionCoil needle, 18 GA x 20 cm, w/ 1 x 5 mm marker, Qty 1 Pre-loaded FusionCoil cartridges, 1 x 5 mm marker, Qty 2	  
MTCTXFC105185	Additional Pre-loaded FusionCoil cartridge, 1 x 5 mm marker, Qty 1	  



ALL FIDUCIAL MARKERS ON THIS PAGE ARE CE MARKED UNLESS NOTED AS NOT CE MARKED

Fiducial Markers

DISEASE SITE RECOMMENDATIONS

HEAD & NECK

BREAST

LUNG

ABDOMEN

PROSTATE

PolyMark™

The PolyMark Marker is the first biocompatible polymer-based marker. It minimizes artifact, is visible using kV based IGRT solutions, MRI and is optimized for Proton Therapy.

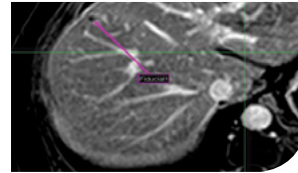

MTCTXPM101820	1 x 3 mm marker	18 GA ETW x 20 cm needle	Qty 1			
MTCTXPM101825	1 x 3 mm marker	18 GA ETW x 25 cm needle	Qty 1			
MTCTXPM0834	0.8 x 3 mm marker Loose, Sterile	-	Qty 4			

PointCoil™



The PointCoil Marker is a 5mm long helical coil that provides a single unique point for IGRT. The helical design maximizes stability and minimizes artifact.

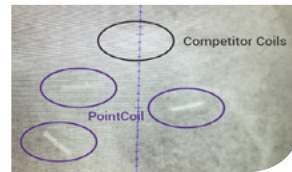

MTCTXPC0605	0.6 x 5 mm marker	20 GA ETW x 20 cm needle	Qty 1			
-------------	-------------------	--------------------------	-------	--	--	--

Optimized for Proton. Minimal shadows when administering treatment.

PointCoil SBRT Kit

Cartridge Kits reduce the number of needle passes and minimize the chance of Edema or Pneumothorax.

MTCTXPC0819153	Trocar placement needle, 19 GA x 15 cm, Qty 1 Pre-loaded PointCoil cartridge, 0.8 x 5 mm marker, Qty 3					
MTCTXPC08185	Additional Pre-loaded PointCoil cartridge, 0.8 x 5 mm marker, Qty 1					



ALL FIDUCIAL MARKERS ON THIS PAGE ARE CE MARKED

Fiducial Markers

DISEASE SITE RECOMMENDATIONS

HEAD & NECK

BREAST

LUNG

ABDOMEN

PROSTATE

FlexiCoil™

The FlexiCoil Marker is a unique, non-migrating marker with solid end points. FlexiCoil provides a unique image with two nodes that clearly define the end points.



MTCTXFC09101820	0.9 x 10 mm marker	18 GA ETW x 20 cm needle	Qty 1		
MTCTXFC12101720	1.2 x 10 mm marker	17 GA ETW x 20 cm needle	Qty 1		

FlexiMarc™ G/T

The FlexiMarc G/T Marker provides distinctive non-biological projection with easily definable nodes. The gold nodes are connected with a fine titanium line, which creates the optimal performance characteristics and visualization.

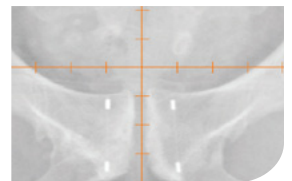

MTCTXGT10182010	1 x 3 mm markers 10 mm spaced	18 GA ETW x 20 cm needle	Qty 1	
MTCTXGT10182020	1 x 3 mm markers 20 mm spaced	18 GA ETW x 20 cm needle	Qty 1	

Optimized for CyberKnife® prostate treatments.

Coupled Markers

Coupled Markers are 3 mm long with either 0.8 or 1.0 mm diameters attached at a fixed distance, 20 mm apart from center to center. They are secured with a sterile, tissue-absorbable material. This ensures that the markers are implanted at a known distance for calculating precise localization.



MTNW887709	0.8 x 3 mm markers	18 GA ETW x 20 cm needle	Qty 2			
MTNW887710	1 x 3 mm markers	17 GA ETW x 20 cm needle	Qty 1			
MTNW887712	1 x 3 mm markers	17 GA ETW x 20 cm needle	Qty 2			
MTNW887711	1 x 3 mm markers 1.2 x 3 mm markers	17 GA ETW x 20 cm needle 17 GA ETW x 20 cm needle	Qty 1 Qty 1			

ALL FIDUCIAL MARKERS ON THIS PAGE ARE CE MARKED

Fiducial Markers

DISEASE SITE RECOMMENDATIONS



Align™

Align Markers are 10 mm long to accommodate localization software systems that utilize linear fiducials as opposed to multiple segment points.



MTNW887883	0.8 x 10 mm marker	18 GA ETW x 20 cm needle	Qty 2			
MTNW887881	1.2 x 10 mm marker	17 GA ETW x 20 cm needle	Qty 2			
MTNW887882	1.2 x 10 mm marker	17 GA ETW x 20 cm needle	Qty 3			

CyberMark™

CyberMark Markers were developed specifically for use with Accuray's CyberKnife robotic radiosurgery system. The gold marker measures 5 mm long and 1 mm in diameter, as specified in the CyberKnife software.



MTNW887851	1 x 5 mm marker	18 GA ETW x 20 cm needle	Qty 1			
MTNW887853	1 x 5 mm marker	18 GA ETW x 20 cm needle	Qty 3			
MTNW887855	1 x 5 mm marker Loose, Sterile	-	Qty 4			

Bone Markers

Bone Markers are 99.9% pure gold 2 mm spheres recommended for head and neck applications. They are typically placed in a small hole in the bone and sealed with bone wax, with minimal marker migration.



MTNW887805 NOT CE MARKED	2 mm diameter Loose, Sterile	-	Qty 3			
-----------------------------	---------------------------------	---	-------	--	--	--

Suture-Type Markers

Suture-Type Markers are designed for high accuracy breast tumor localization. The 99.9% pure gold spheres with small central holes are readily sutured in place to provide a permanent localization solution. They are prethreaded on absorbable sutures.



MTNW887866	2 mm diameter	-	Qty 3			
------------	---------------	---	-------	--	--	--

ALL FIDUCIAL MARKERS ON THIS PAGE ARE CE MARKED UNLESS NOTED AS NOT CE MARKED

Fiducial Markers

DISEASE SITE RECOMMENDATIONS



Gold Soft Tissue Markers

Gold Soft Tissue Markers are 99.9% pure gold cylinders specially knurled to inhibit migration. They are 3 mm long and 0.8, 0.9, 1.2 or 1.6 mm in diameter. They are available loose or in sterilized preloaded needles.



MTNW887871	0.9 x 3 mm marker	18 GA ETW x 12 cm needle	Qty 1			
MTNW887870	0.9 x 3 mm marker	18 GA ETW x 12 cm needle	Qty 3			
MTNW887872	0.9 x 3 mm marker	18 GA ETW x 20 cm needle	Qty 1			
MTNW887873	0.9 x 3 mm marker	18 GA ETW x 20 cm needle	Qty 3			
MTNW887830	1.2 x 3 mm marker	17 GA ETW x 20 cm needle	Qty 1			
MTNW887825	1.2 x 3 mm marker	17 GA ETW x 20 cm needle	Qty 3			
MTNW887840	1.2 x 3 mm marker	17 GA ETW x 20 cm needle	Qty 4			
MTNW887836	1.2 x 3 mm marker	17 GA ETW x 30 cm needle	Qty 1			
MTNW887835	1.2 x 3 mm marker	17 GA ETW x 30 cm needle	Qty 3			
MTNW887837	1.2 x 3 mm marker	17 GA ETW x 30 cm needle	Qty 4			
MTNW887860	1.6 x 3 mm marker	14 GA ETW x 20 cm needle	Qty 3			
MTNW887808	0.8 x 3 mm marker Loose, Sterile	-	Qty 3			
MTNW887809	0.9 x 3 mm marker Loose, Sterile	-	Qty 3			
MTNW887810	1.2 x 3 mm markers 10 mm spaced	17 GA ETW x 20 cm needle	Qty 1			
MTNW887812	1.2 x 3 mm marker Loose, Sterile	-	Qty 3			



ALL FIDUCIAL MARKERS ON THIS PAGE ARE CE MARKED

Fiducial Markers

DISEASE SITE RECOMMENDATIONS



HEAD & NECK



BREAST



LUNG



ABDOMEN



PROSTATE

Accusyte™

The Accusyte 3D Fiducial Marking System marks the planes of a soft tissue cavity after a tumor has been removed. The fiducial sutures are used when soft tissue needs to be marked for future medical procedures, such as subsequent radiation therapy.

After a biopsy or tumor removal, the Accusyte fiducial sutures are sewn around the perimeter of the tumor bed at the anterior, posterior, middle, and lateral planes of the tumor cavity. The fiducials allow for accurate delineation of target volumes during treatment planning and assist with image guided radiation therapy (IGRT) before each session.





The fiducial markers are woven within an absorbable suture. When the body absorbs the suture, the fiducial markers remain within the tissue. Migration of the markers from their original position is unlikely, as the tissue produced during the healing process holds the markers in place.

Each package contains six sutures, which are sewn into place using the same technique as other sutures commonly used.

ONLY AVAILABLE IN THE U.S.



MTSRP104 Accusyte 3D Fiducial Marker Suture Set 1 x 4 mm Qty 6 sets

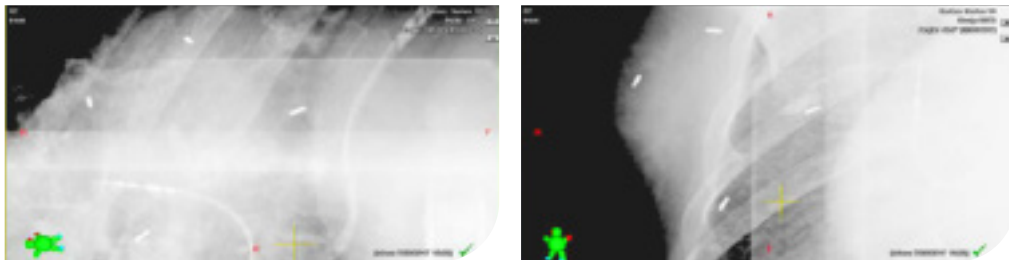

Fiducial Markers

BioXmark® Liquid Fiducial Marker NEW! Manufactured by Nanovi

The liquid nature of BioXmark enables implantation of multiple markers of varying sizes in the same uninterrupted procedure. Following implantation, sticky and soft markers form, adapting to the surrounding tissue* and remaining visible under relevant imaging, including MRI. BioXmark markers are non-metallic and have low levels of artifacts and low-dose perturbation. These qualities support precise treatment planning and image-guided treatment, including proton therapy. Achieve CT and MRI image acquisitions while ensuring streamlined workflows and low risk of complications, all without specialized equipment.



CONTACT US FOR AVAILABILITY IN YOUR MARKET

11210590	BioXmark Liquid Fiducial Marker	Qty 5/box
----------	---------------------------------	-----------

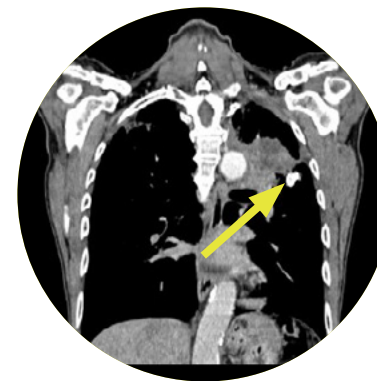

BioXmark in Lung Tumor Planning CT Scan



BioXmark in Bladder Planning CT Scan

*BioXmark has De Novo clearance from the US FDA with an indication for use to radiographically mark lung, bladder and lymph nodes in adult patients. For markets outside the U.S., BioXmark is indicated for use to radiographically mark soft tissue (bladder, esophagus, liver, lung, lymph nodes, rectal, stomach, pancreas, head & neck).

Patient Marking

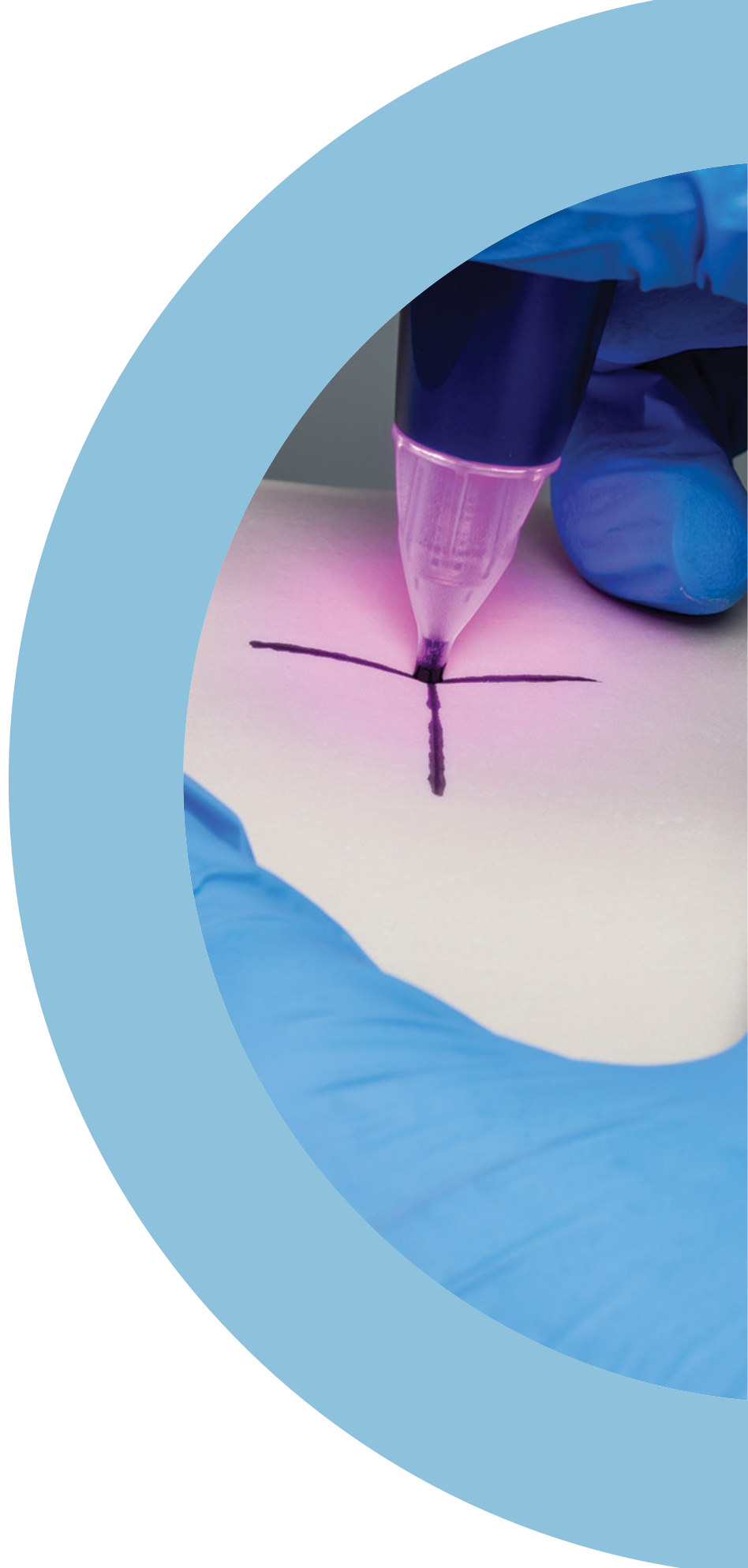

Comfort Marker 2.0 Patient Marking System

Improve your patient's radiotherapy journey and gain clinical efficiencies with the Comfort Marker 2.0, developed by Medical Precision B.V. This revolutionary reference point device brings a new level of comfort to the start of the patient's radiotherapy treatment.

The easy-to-use system is designed specifically for use in radiotherapy using technology popular within the permanent make-up industry. The device is carefully engineered to apply reference marks with gentle and controlled depth placement, resulting in less painful tattooing to help keep the patient relaxed and cooperative throughout the process.

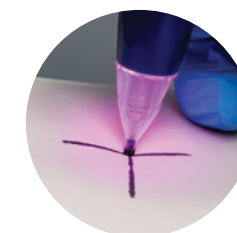

Medical
Precision b.v.

PATIENT BENEFITS

- Less painful tattooing keeps patients relaxed and more cooperative throughout the process
- Shallow and depth-controlled pigment placement compared to handheld lancets
- Result in cosmetically more pleasing tattoos that keep a round, uniform shape with well-defined edges

CLINICIAN BENEFITS

- Sterile, easy to attach, and disposable safety needle module minimizes risks of needle stick accidents
- Simple depth setting selection with haptic and color feedback
- Rechargeable battery-powered device allows freedom of motion within CT room for medical professionals

DEVICE BENEFITS

- Patients marked with Comfort Marker 2.0 reported less procedural pain than patients marked with lancets
- Physicians and radiation therapists doing photographic assessment of cosmesis rated Comfort Marker 2.0 better than lancets*
- Radiation therapists rated placing tattoos with Comfort Marker 2.0 easier compared to the use of lancets

*Limitation/additional information: study performed in Europe where majority of the population is Caucasian race, specific to Portugal where the study was performed the majority is from a Mediterranean ethnicity.



Safety Needle, Ink Cup, Pigment

Comfort Marker 2.0

CUSTOMERS OUTSIDE THE U.S.

U.S. CUSTOMERS

Comfort Marker 2.0 System, Qty 1	MPCM2010INT	MPCM2010
Patient Marking Set. Includes: Safety Needle (Qty 50), Ink Cup (Qty 50), Black Pigment (Qty 50)	MPCM4022INT	MPCM4022

CE MARKED. FDA DE NOVO AND 510(K) CLEARED

InkAlign™

Convenient, easy to use applicator to help regulate the flow of ink.

MAXIMIZES PATIENT SAFETY

Each applicator device contains hypo-allergenic, sterile, non-toxic permanent ink that is safety sealed and gamma-irradiated; assuring sterility.

DIFFERENTIATES NEW AREAS FROM PREVIOUS TREATMENT SITES

UV pink ink takes away the daily reminder of radiation. UV pink ink is visible under UV light allowing patients to not have unsightly marking tattoos. UV pink provides an alternative ink color to be used to identify different areas of treatment or differentiate new areas from previous treatment sites. UV pink can be used on all skin tones.

EASY TO USE AND REPEATABLE

InkAlign is a sterile, single-use medical tattooing product with a pen-like design that provides standardized administration of radiation therapy tattooing. The ink applicator comfortably rests in the technician's hand for easy control of ink flow during application to skin.

InkAlign is available in packs of 25 sterile single-use devices with 21 gauge needles in UV pink or black ink. A box of 10 sterile single-use black ink droppers is also available (needles not included).

Available for sale in the USA and Canada. Contact sales for questions about other geographies.

THESE PRODUCTS HAVE NOT BEEN CE MARKED

RT-4426-OUVN	InkAlign, UV pink, Box of 25 Applicators*
RT-4426-OBKN	InkAlign, Black, Box of 25 Applicators*
RT-4426-DBK	InkAlign, Dropper, Black, Qty 10/Box
RT-4426-UVTL-02	UV Tattoo Light, 1" D x 3.5" H (25mm D x 89mm H)

* Includes 21 gauge surgical grade, sterile hypodermic needles.

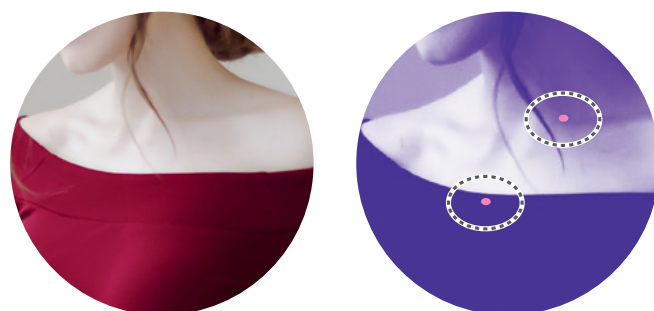

UV pink ink under natural light

UV pink ink under UV Tattoo Light



Available in UV pink or black ink



UV Tattoo Light

Suremark™ Markers

Suremark

Suremark markers are useful in distinguishing between a nipple shadow and lesion.

MTSL10	ball size of 1.0 mm, Qty 110/Box
MTSL15	ball size of 1.5 mm, Qty 110/Box
MTSL20	ball size of 2.0 mm, Qty 110/Box
MTSL25	ball size of 2.5 mm, Qty 110/Box

Powermark™

Powermark markers maintain the advantages of Suremark markers and feature larger lead ball sizes for visibility in radiation therapy.

MTSL30	ball size of 3.0 mm, Qty 50/Box
MTSL40	ball size of 4.0 mm, Qty 50/Box

Suremark Wire

Suremark Wire is used for marking scar tissue, outlining palpable nodules, moles and entry points in CT scans.

MTSLW3	wire width of 0.3 mm, 336 cm
MTSLW4	wire width of 0.4 mm, 336 cm
MTSLW8	wire width of 0.8 mm, 336 cm

Suremark Tabs

Suremark Tabs maintain the advantages of the Suremark markers with an added tabbed feature.

MTSL15T	1.5 mm, Qty 110/Box
MTSL20T	2.0 mm, Qty 110/Box

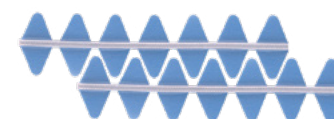

Suremark Markers

Visionmark™

Visionmark markers are specially formulated non-metallic markers that perform consistently and accurately in a variety of applications. An excellent tool for distinguishing between nipple shadow and lesion, the Visionmark reduces the need for repeat examinations.

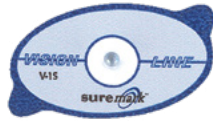

MTSLV20	ball size of 2.0 mm, Qty 110/Box
MTSLV25	ball size of 2.5 mm, Qty 110/Box
MTSLV30	ball size of 3.0 mm, Qty 50/Box
MTSLV40	ball size of 4.0 mm, Qty 50/Box
MTSLV50	ball size of 5.0 mm, Qty 50/Box

CT Mark and CT Wire Mark

CT Mark new blue formulation is specifically designed for CT and will not cause artifact.

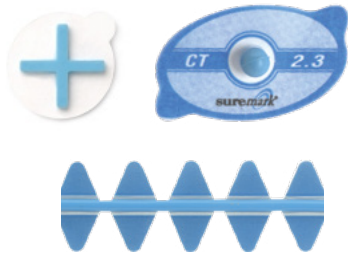

MTCT23	ball size of 2.3 mm, Qty 110/Box
MTCT40	ball size of 4.0 mm, Qty 50/Box
MTCTW10	1.0 mm line, 300 cm
MTCTW20	2.0 mm line, 300 cm
MTCTCR3	Cross, 1.2 cm, Qty 50/Box

LiquiMark™ MRI Markers

LiquiMark fiducial markers are non-metallic, latex-free, and perform consistently and accurately in a variety of applications. Qty 40/Box.



MTSLLM1	8 mm round - for small field of view areas
MTSLLM2	15 mm tube - for extremities, soft tissue, and breast

Suremark Markers



Clearline™ Scar Markers

Clearline low-density scar markers provide distinct outlining of scars and other areas of concern without obscuring micro-calcifications in mammography. These markers are non-metallic and are specifically formulated to eliminate scatter in CT applications.

MTSLCL20	semi-lucent lines of 2.0 mm, 320 cm
MTSLCL25	semi-lucent lines of 2.5 mm, 203 cm

Suremark Relief Tabs

Suremark Relief Tabs have a unique adhesive-free center that won't stick to sensitive areas of the skin.

MTSL25RT	2.5 mm, Qty 110/Box
-----------------	---------------------

Portal Markers

Set of marker tapes designed to outline the treatment field. This product is useful when planning multiple fields of treatment.

- Long lasting
- Comfortable
- Minimizes tattooing
- Water resistant

THESE PRODUCTS HAVE NOT BEEN CE MARKED

MTPM150	Isocenter, 18 isocenters and 6 field lines, 50 Sheets
MTPM350	25 mm transparent label to delineate skin mark, Qty 110/Box

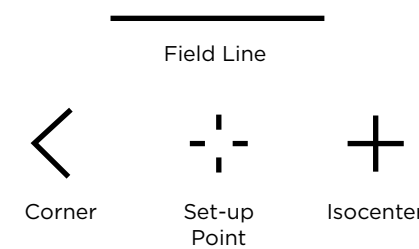

Additional Markers

Disposable Rectal & Vaginal Markers

ShadowForm® Markers are used for simulation and CT planning. They are available in Rectal and Vaginal Markers; both have flexibility. They have a T-bar handle and can easily be removed for the optional insertion of barium.

- Materials promote patient comfort and provide ease of use
- Visible on any x-radiation modality
- Disposable, single use only

THESE PRODUCTS HAVE NOT BEEN CE MARKED

MTZM1710	Disposable Rectal Marker, 10 cm long Qty 10/Box
MTZM1740	Disposable Rectal Marker, 38 cm long Qty 10/Box
MTZM1735	Disposable Vaginal Marker, 18 cm long Qty 10/Box

Setup Rulers

Great aid to help with the setup of patients. These rulers start at "0 mm" from the edge. For reference only.

CQRULER	Qty 1
---------	-------



Additional Markers

DecoColor™ Markers

Oil-based paint markers that are acid-free, lead-free and non-toxic. Available in an assortment of colors.

(DecoColor markers are intended to be used for marking masks and shells, not for use in marking directly on skin.)

RT-4420-DCWT	Fine Line, White, Qty 12
RT-4420-DCBL	Fine Line, Blue, Qty 12
RT-4420-DCVT	Fine Line, Violet, Qty 12



Sharpie® Markers

Fine point Sharpie Markers fast-drying, acid-free ink is ACMI certified non-toxic.

(Sharpie markers are intended to be used for marking masks and shells, not for use in marking directly on skin.)

RT-4420-SPBK	Black, Qty 1
RT-4420-SPBL	Blue, Qty 1
RT-4420-SPGN	Green, Qty 1
RT-4420-SPRD	Red, Qty 1

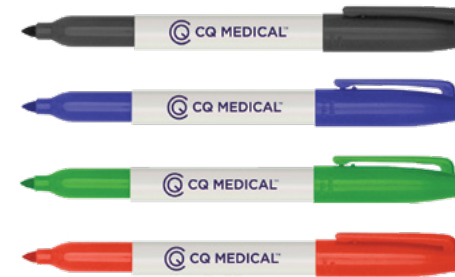

MRSeries™

Always refer to product labeling to identify whether a device is MR Safe or MR Conditional.

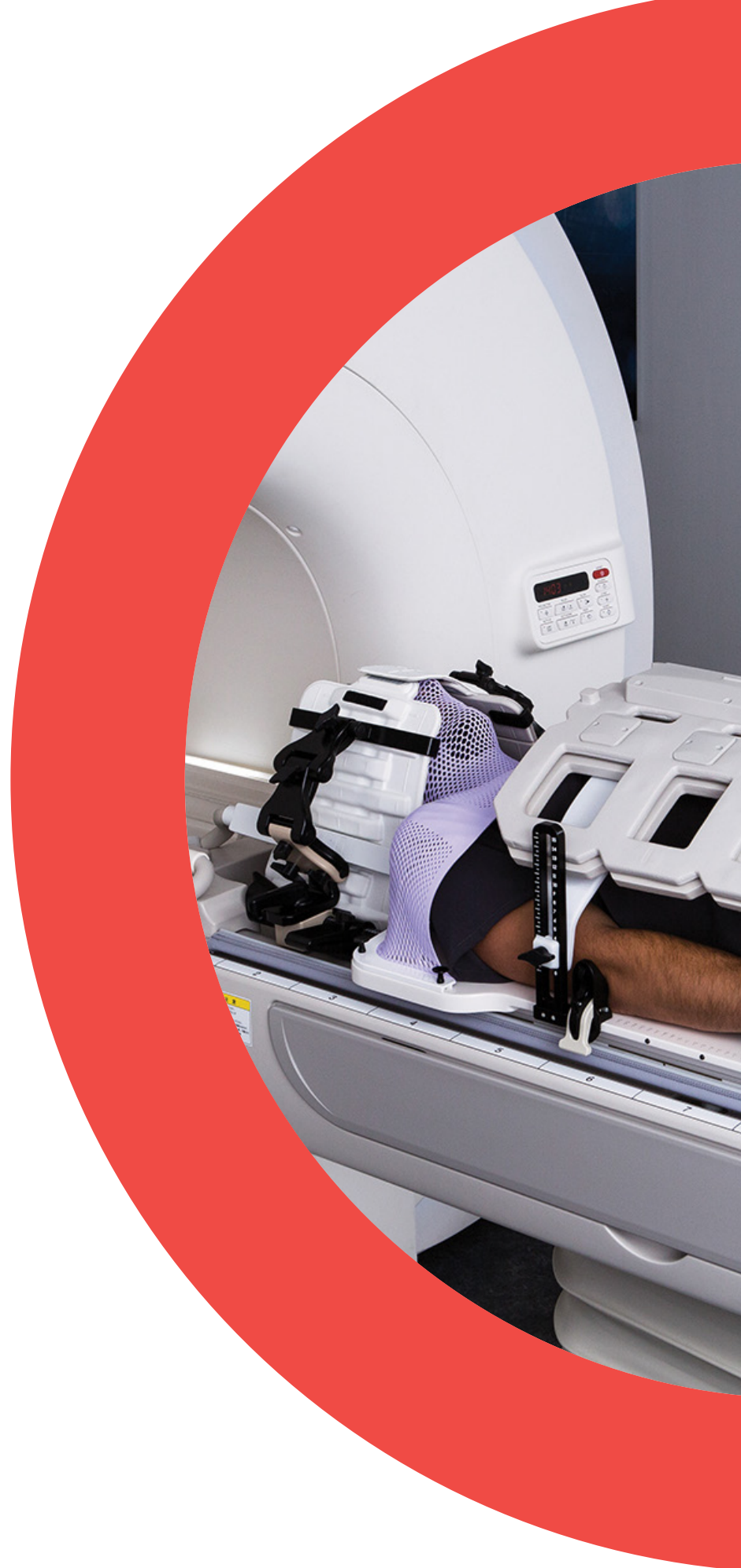

Universal Couchtop MRI Overlays

Universal Couchtop MRI Overlays are made from fiberglass and feature Prodigy 2 indexing in 7 cm increments. Universal Couchtop is available on most major CT, MR, Proton and LINAC models to provide seamless transfer from imaging to treatment.

- MR Lok-Bar offers the option to use existing MR Safe or MR Conditional devices by indexing them to the overlay
See pages 6-23 for additional information on Universal Couchtop.



UNIVERSAL COUCHTOP MRI OVERLAY FOR:	INDEXING STYLE	COMPATIBLE LOK-BAR	PART #
SIEMENS			
MAGNETOM Vida, Skyra 3T (with Type-S & Posifix mask attachment)	Prodigy 2	MTIL6054	MTM3004
MAGNETOM Sola, Aera 1.5T (with Type-S & Posifix mask attachment)	Prodigy 2	MTIL6054	MTM3004
CANON			
Vantage Galan 3T	Prodigy 2	MTIL6054	-
Vantage Orian 1.5T	Prodigy 2	MTIL6054	-

Contact Canon Medical for more information

MR Lok-Bar

MR Lok-Bars allow you to index MR Safe or Conditional devices to your MRI overlay.

MTIL3351	Interloc 50 cm
MTIL3352	Interloc 53 cm
MTIL3454	Prodigy 50 cm
MTIL6054	Prodigy 2, 53 cm

Elekta Unity MR-LINAC Two-Pin Lok-Bar

MTULB001	
MTULB002	QA Lok-Bar, contains spacer support for a stable and consistent base



INSIGHT MR Overlay & Coil Holders

INSIGHT COMPATIBLE WITH SIEMENS MAGNETOM AERA, ALTEA, LUMINA, SKYRA, VIDA, AND SOLA TABLES

INSIGHT MR Overlay and Coil Holders are designed to enable MR imaging in the same position as treatment, supporting MR/CT fusion techniques as well as MR only.

MR OVERLAY

- Features Varian Exact® Indexing notches every 70 mm
- Compatible with Type-S Head Only and Head, Neck & Shoulders thermoplastic masks

COIL HOLDERS

- Intended to position body and head coils allowing the patient to undergo imaging in the same position as that of the treatment position
- Coil holders support scanners using the Flex 4, Body 6, and Body 18 coils

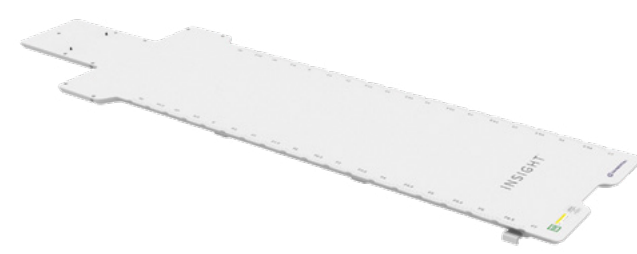
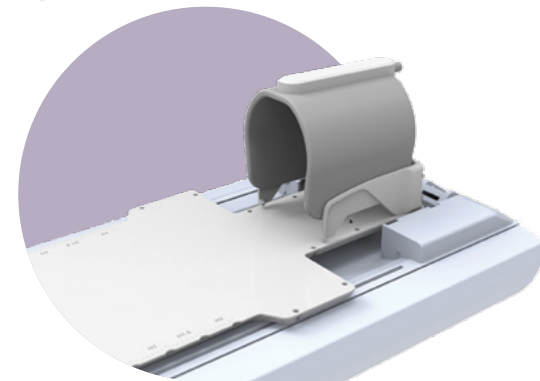
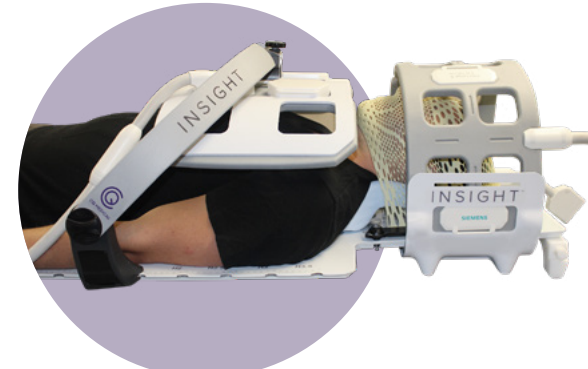

RT-4700-10 Includes INSIGHT MR Overlay, Head Coil Holder and Body Coil Holder

INSIGHT COMPATIBLE WITH SIEMENS MAGNETOM FREE.MAX SCANNERS

INSIGHT MR Overlay and the Coil Holder are designed to enable MR imaging in the same position as treatment.

MR OVERLAY

- Features Varian Exact® Indexing notches every 70 mm
- Compatible with Type-S Head Only and Head, Neck & Shoulders thermoplastic masks

COIL HOLDER

- The head coil holder positions an anterior MRI coil in close proximity to the patient's head without disturbing the anatomy

RT-4700-20 Includes INSIGHT MR Overlay and Head Coil Holder

Alta Multipurpose Device

ELEVATE YOUR WORKFLOW

Alta is an all in one solution that quickly adapts to a wide range of setups, for a more user friendly and ergonomic experience.

- Combines functionality of multiple devices
 - Dependable and reproducible
 - Fast and efficient setups
 - Can be extended beyond end of couchtop for improved head and neck dosimetry
 - Lightweight—5.4 kg (12 lbs)
 - MR Safe, CT and treatment compatible
- See pages 41-43 for more details.



TotalRT All in One Platform

The TotalRT All in One Platform is designed to quickly adapt positioning and immobilization solutions to your clinical setup and treatment needs. The platform is indexable on a couchtop, creating an affordable all in one solution and allowing seamless transition between patient treatments.

See pages 44-45 for more details.

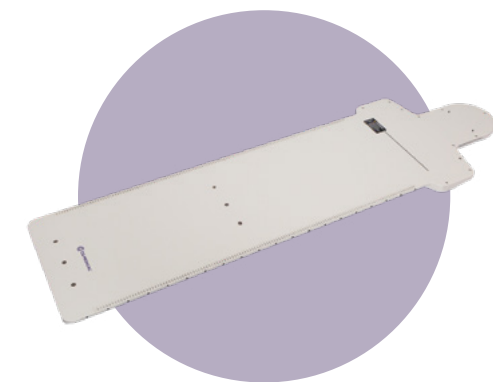

Overlays

MRI overlays are made of fiberglass with a foam core, have Prodigy and Interloc indexing options and are compatible with MR Lok-Bars.

MRI OVERLAY FOR:	INDEXING STYLE	COMPATIBLE LOK-BAR	PART #
PHILIPS			
Ingenia Ambition, Ingenia Elition	Interloc	MTIL3352 (2 included)	MTM3404
GE			
Wide Bore (750w or 450w) with GEM	Interloc	MTIL3352 (1 included)	MTM3302
SIEMENS			
Aera, Skyra, Vida, Prisma (with Type-S mask attachment)	Prodigy	MTIL3454 (1 included)	MTM3002
Aera, Skyra, Vida, Prisma (with Posifix mask attachment)	Prodigy	MTIL3454 (1 included)	MTM3003

Encompass 15-Channel Head Coil for MR Imaging

OPTIMIZED FOR USE WITH THE ENCOMPASS MR SRS IMMOBILIZATION SYSTEM

The Encompass 15-Channel Head Coil is specially designed to accommodate the high-precision positioning unique to the Encompass MR SRS Immobilization System.

The adjustable coil geometry locates the coil elements within millimeters of each patient's unique anatomy providing an optimized signal-to-noise ratio and delivering imaging information to support accurate SRS treatment planning when used with the Encompass MR SRS Immobilization System.

Immobilization in the Encompass SRS System offers motion reduction for increased visualization of fine details, reducing the need for repeated scans. MR images obtained with the Encompass SRS System can be used for SRS treatment planning, including MR-Only and MR Fusion Techniques.

Please note: Encompass Coil is used with the Encompass MR Device for Imaging Only. Encompass Coil is not for Treatment. The Encompass Device can be used for both imaging and treatment.

RT-5200-01 Encompass 15-Channel Head Coil



Encompass SRS MR Standalone Device

Device Length: 1358 mm
 Handling Weight: 5.5 kg (12 lb)
 Weight Limit: 249 kg (550 lb), Uniformly Distributed Load at maximum cantilever position indicated on device

RT-4600-01-MRI

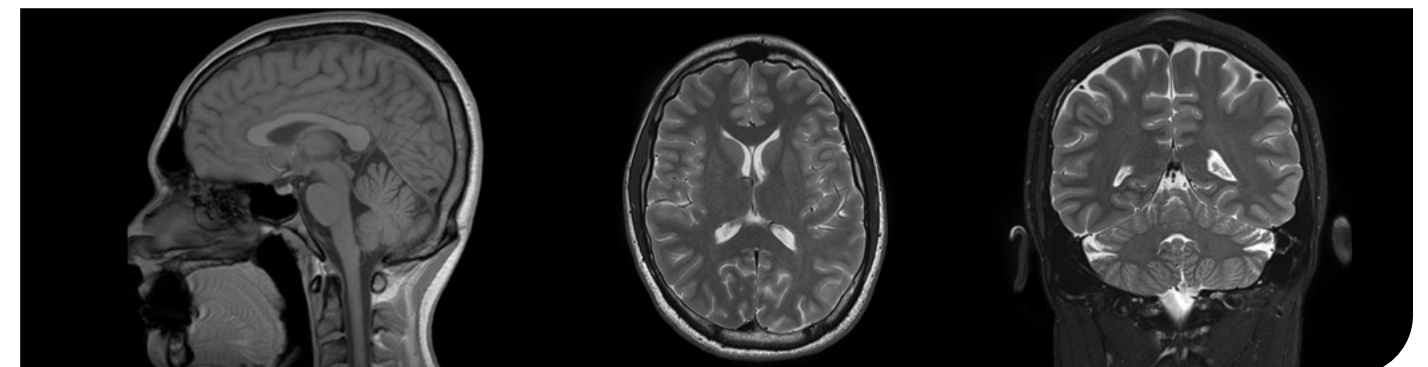

MRSeries Positioning Devices

HEAD & NECK



**Solstat
Immobilization System**
Page 112



**Portrait MR Head
& Neck Device**
Page 89

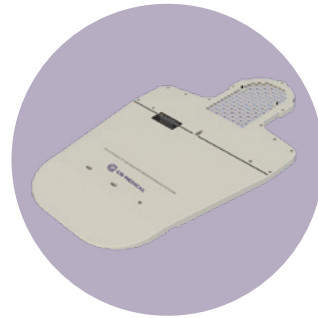

MRI Type-S Overlay
Page 90

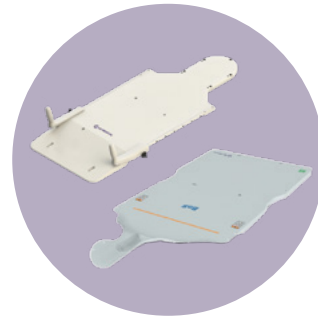

ProForm MR Overlay
Page 209
BoS MR Headframe
Page 205

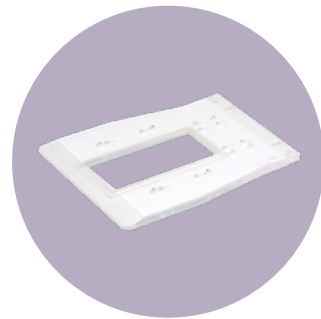

Acrylic Baseplates
Uni-frame Page 100
Posifix Page 105



**Polycarbonate
Headboard**
Page 99



Thermoplastics
Type-S Pages 92-98
Uni-frame Pages 101-103
Posifix Pages 106-108
Pediatric Page 111
Precise Bite Page 116



**Customizable
Head Support**
Page 114
AccuForm Cushions
Page 115



Headrests
Pages 117-121

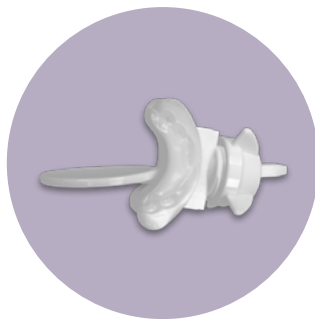

**GrayDuck Oral
Positioning Stents**
Page 113

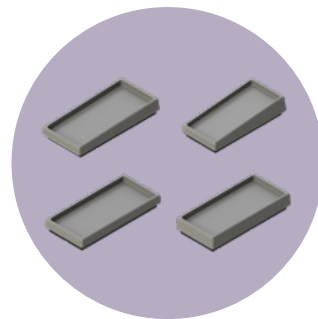

MR Spacers & Wedges
Page 120

MRSeries Positioning Devices

SRS/SRT



**Encompass SRS MR
Head & Neck Device**
Page 70



**Solstice MR SRS
Immobilization System**
Page 74

SBRT, LUNG & ABDOMEN

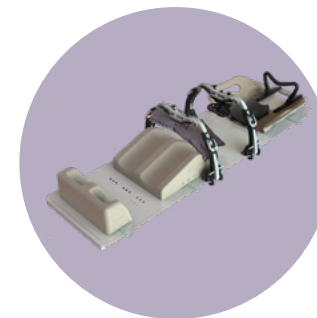

Body Pro-Lok ONE
Page 49

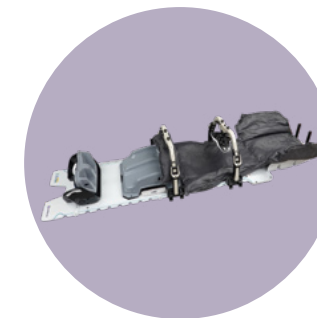

Alta SBRT Immobilization
Page 50



ZiFix Traverse
Page 59

BREAST & THORAX



**C-Qual M
Breastboard**
Page 130



**Access Supine MR Breast
& Lung Treatment Device**
Page 133

**Access Prone G2
Breast Device**
Page 141



**Evolve
Breastboard**
Page 137



Wing Boards
Pages 131 & 144

MRSeries Positioning Devices

HIP & PELVIS



**ThermFix & HipFix
Immobilization Systems**
Page 148



**FlexLock Knee &
Foot Supports**
Page 152



Combifix 3
Page 153



MR Bellyboard
Page 153
SofTouch Elite Bellyboard
Page 156

PATIENT CUSHIONS & POSITIONING AIDS

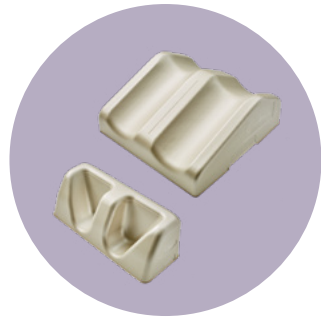

**Kneefix 3
& Feetfix 3**
Page 155



**Vac-Lok and
VacQfix Cushions**
Pages 160-167

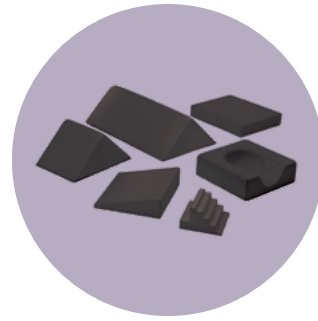

**Multipurpose
Support Cushions**
Page 171



SofTouch Couchtop Pads
Page 25

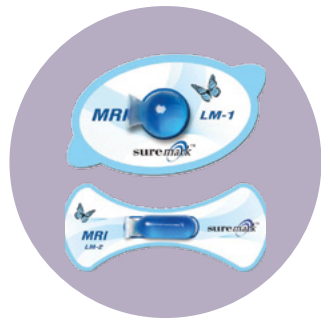

**LiquiMark MRI
Markers**
Page 187

ProtonSeries®



NEW! PRONUMBRA HEAD & NECK SYSTEM
THE NEXT GENERATION OF PROTON THERAPY IMMOBILIZATION
See page 203 for more information.

CHOOSING A PROTON HEAD & NECK POSITIONING SYSTEM*

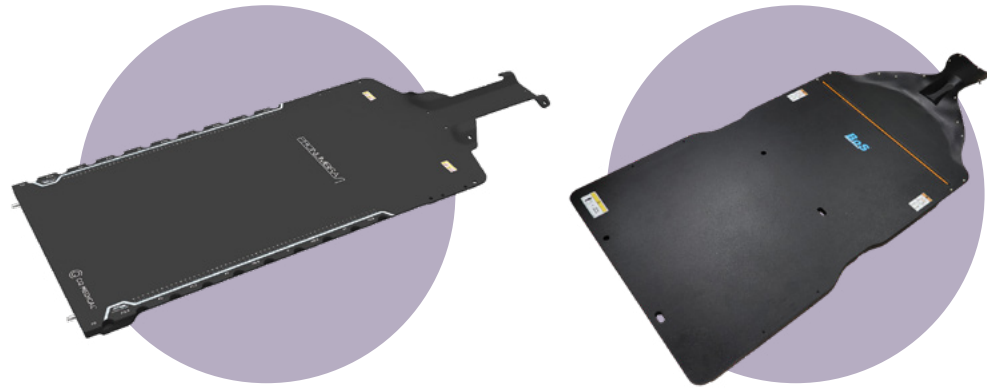

Pronumbra™ NEW!

The next generation of proton head & neck immobilization is here. The Pronumbra system's conformal design ensures the most effective treatment beam angles. Pronumbra offers stunning improvements compared to the legacy BoS system.
Page 203

BoS® Headframe

The BoS system's conformal shape provides optimal treatment beam angles and has been a standard for head & neck immobilization in proton therapy over the last 16 years.
Pages 206-207

COUCHTOP COMPATIBILITY	kVue	kVue
EXTENSION OR INSERT OPTION	Insert, multiple lengths coming soon	Yes, multiple lengths
INDEXING STYLE	Varian Exact	Varian Exact
CT OVERLAY OPTION	Contact Sales	Yes
MR OVERLAY OPTION	Contact Sales	Yes
THERMOPLASTIC MATERIAL	Fibreplast	Fibreplast and Aquaplast RT
THERMOPLASTIC SPECIAL FEATURES	Hair Opening, Standard Perf, Micro Perf	Open-face, Hair opening, Cranial flap, Standard Perf, Micro Perf
POSTERIOR HEAD SUPPORT	Neck Supports with Customizable Cushion	Foam Headrest, Customizable Cushion
SHIM OPTION	Integrated in Frame, 0.5 mm increments	Precut Foam Shim

*These devices offer many configurations and compatibilities. Please consult your sales representative for more information.

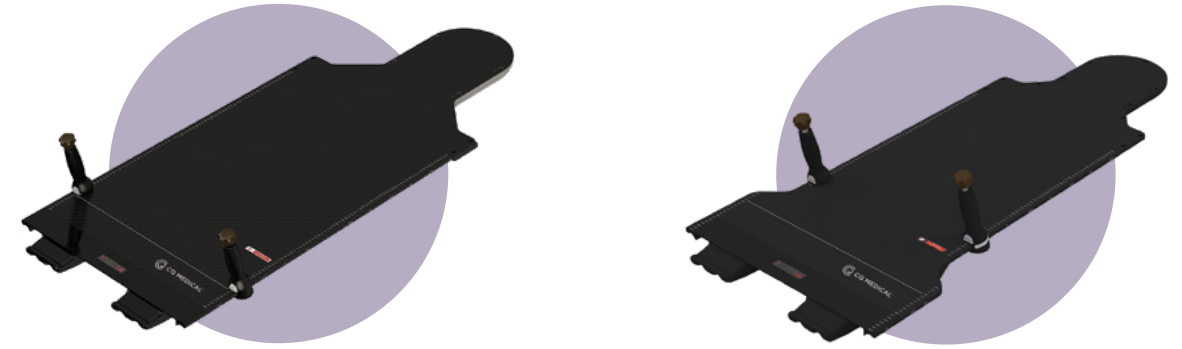

ProForm™

The ProForm system provides an easy to use mask attachment and a homogenous treatment region optimized for CNS patients.
Pages 209-211

Pediatric ProForm

Pediatric ProForm complements the adult ProForm solution and provides a solution fully optimized for positioning your pediatric patients.
Pages 212-213

Universal Couchtop	Universal Couchtop
Yes, multiple lengths	Yes
Prodigy 2	Prodigy 2
Yes	Yes
Yes	Yes
Aquaplast RT	Aquaplast RT
Pre-cut eye and mouth, Open-face, Reinforced, Hair opening, Solid	Pre-cut eye and mouth, Open-face, Reinforced
Customizable Cushion	Customizable Cushion
AccuForm Shim	AccuForm Shim

kVue One Proton Couchtop

The kVue One Proton Couchtop is rigid, lightweight and specifically designed for use with a robotic couch, which is frequently used in proton therapy applications. The versatile kVue platform provides a wide range of positioning and immobilization options for treating tumors of varying complexities.

The expansive array of kVue inserts provide clinicians the flexibility to develop and manage treatments that are best suited for a patient's specific treatment needs. All kVue inserts are easily adapted to a variety of radiotherapy treatments in one simple solution.

- Specifically designed to provide range shift confidence for proton therapy
- Interchangeable inserts for full range of proton therapy treatments
- For use with a robotic couch

RT-4551KV-03 kVue One Proton Couchtop

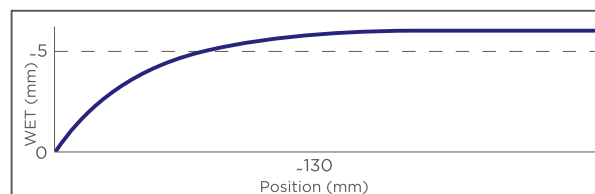
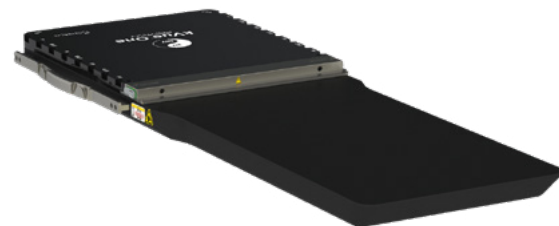
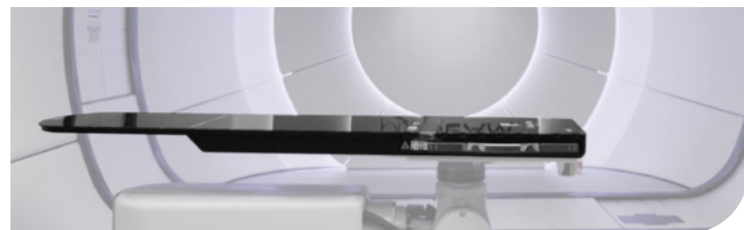

Typical kVue One Proton Water Equivalence Profile

kVue Proton Couchtop

The kVue Proton Couchtop is specifically designed for use with robotic couches.

MANY KVUE STANDARD INSERT OPTIONS ARE AVAILABLE. CONTACT YOUR SALES REPRESENTATIVE FOR MORE INFORMATION.

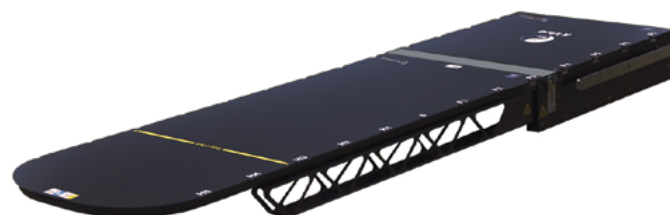

kVue Pronumbra Head & Neck System **NEW!**

CAREFULLY CRAFTED FOR PHYSICISTS

The device's conformal design, combined with customizable patient positioning options, optimizes the proton beam penumbra, and maximizes treatment angles to achieve the best possible outcomes.

IMPROVED THERAPIST WORKFLOW

We've packed in our top-of-the line features like Helping Hands for consistently crafted, customizable head cushions, thermoplastic Integrated Shim technology for instant setup feedback, and an intuitive mask pin system for a more efficient setup and treatment process.

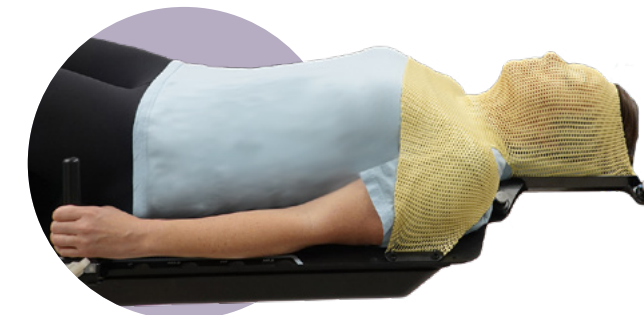

Achieve precise cushion shaping for improved treatment planning with the innovative Helping Hands™ device



Adjust the mask's fit in critical areas using the Integrated Shim for precise control



Headrest options enhance patient positioning and improve cushion indexing for better overall comfort and accuracy



Clearly visible docking locations and a standard thermoplastic pin system ensure intuitive and effortless use



RT-4536KV-100 kVue Pronumbra Insert, 130 cm Package. Includes insert, neck supports (3 sizes), Helping Hands cushion manager, shoulder adapters, InfinityLock hand grips, and locking locating bar.



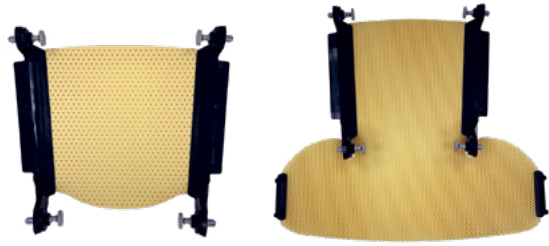

Fibreplast with Integrated Shim Thermoplastics

RT-C876K	Head Only, Microperf, 3.2 mm, Qty 5/Box
RT-C889K	Head Only, Standard Perf, 3.2 mm, Qty 5/Box
RT-C878K	Head, Neck & Shoulders, Microperf, 3.2 mm, Qty 4/Box
RT-C829K	Head, Neck & Shoulders, Standard Perf, 3.2 mm, Qty 4/Box

Pronumbra Neck Support

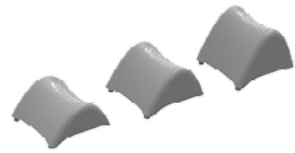

RT-4536-NS40	40 mm
RT-4536-NS50	50 mm
RT-4536-NS65	65 mm

Pronumbra Shoulder Adapters



RT-4536-SA01

InfinityLock™ Hand Grips



RT-4800-04

AccuForm Cushions



MTACL2035	20 x 35 cm
MTACL2035HF	20 x 35 cm Chamfered

Locking Locating Bar



RT-4551BAR-05

BoS Inserts

kVue BoS inserts are specifically designed to meet the unique requirements of proton therapy for patient immobilization and beam transmission. The BoS device is engineered to rigidly support the patient without using a flat base that blocks the use of important proton beam angles.

The conformal shape is designed to minimize the distance between the patient and the field defining aperture, optimizing the beam proton penumbra.

kVue BoS inserts are available in two additional lengths. The shorter version which is required to treat vertex fields in some robotic couch setups and a longer version that is required to treat lower spinal fields on tall patients.

RT-4535KV	Standard length, 132 cm
RT-4535KV01	Shorter length, 121 cm
RT-4535KV03	Longer length, 158 cm

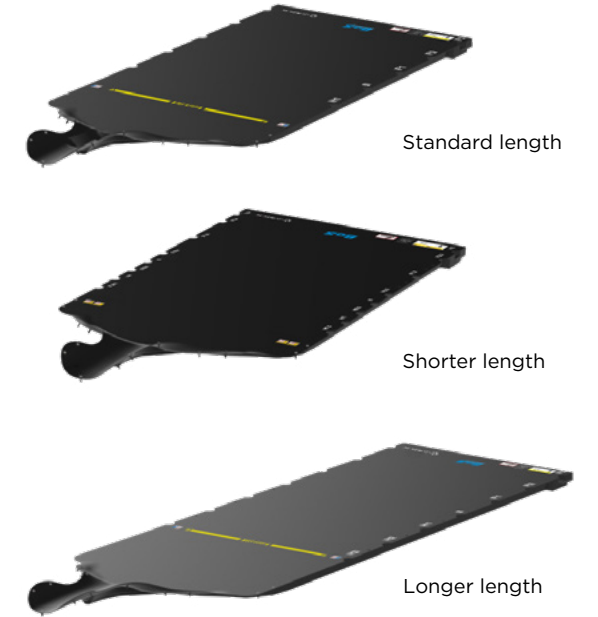

BoS Headframes

The BoS Headframe is engineered to rigidly support the patient without using a flat base that blocks the use of important proton beam angles. The BoS MR Headframe enables enhanced imaging in both CT and MR while also facilitating the use of CT fusion techniques.

RT-4535BOSMRI	BoS MR Headframe
RT-4535BOS	BoS Headframe

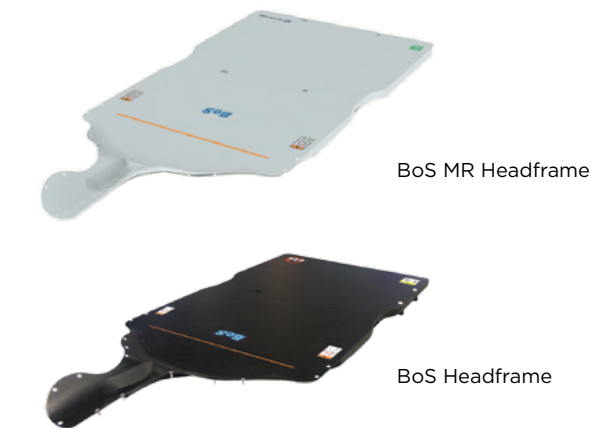

BoS Accessories

RT-4490BOS1	Foam Headrest, Qty 1
RT-4485	Precut Foam Shim for BoS Headframe, Qty 1
RT-4525HGA	Hand Grips, Pair
RT-4492U	AccuForm U Head Cushion, 20 x 35 cm

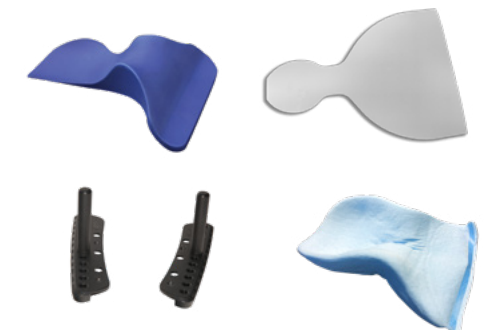

BoS Thermoplastics

Masks on this page are disposable and sold in Qty 1. Must purchase in multiples of 10.

The innovative 3D shape matches the contour of the BoS device, which is designed to meet the unique requirements of proton therapy for patient immobilization and beam transmission. These masks come in a variety of different options, allowing for head and neck as well as head and shoulder immobilization.



Head & Neck, 24 cm wide for smaller patients

RT-1782BOS-DXS	Aquaplast RT (Extra Small), Standard Perf, 2.4 mm
RT-1882KBOS-DXS	Fibreplast (Extra Small), Standard Perf, 3.2 mm

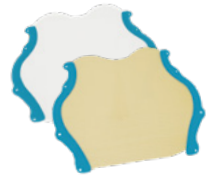

Head & Neck, 26 cm wide, 3.2 mm

RT-1878BOS-D2LVS	Aquaplast RT, Micro Perf with Cranial Flap
RT-1878KBOS-D2LVS	Fibreplast, Micro Perf with Cranial Flap
RT-1882BOS-DVS	Aquaplast RT, Standard Perf
RT-1882KBOS-DVS	Fibreplast, Standard Perf



Head & Neck, Head & Shoulders, 3.2 mm

RT-1878KBOS-D2LSF	Assure™ Open View Fibreplast Head & Neck, Micro Perf with Cranial Flap, 31 cm wide
RT-1878KBOS-E2LF	Assure Open View Fibreplast Head & Shoulders, Micro Perf with Cranial Flap, 43 cm wide



BoS Thermoplastics

Masks on this page are disposable and sold in Qty 1. Must purchase in multiples of 5.

Head & Neck, 31 cm wide, 3.2 mm

RT-1878BOS-D2LS	Aquaplast RT, Micro Perf with Cranial Flap
RT-1878KBOS-D2LS	Fibreplast, Micro Perf with Cranial Flap
RT-1882BOS-DS	Aquaplast RT, Standard Perf
RT-1882KBOS-DS	Fibreplast, Standard Perf

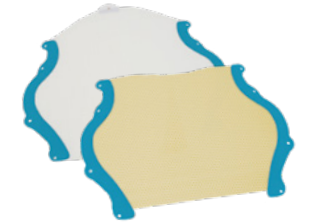

Head & Neck, 38 cm wide, 3.2 mm

RT-1878BOS-D2L	Aquaplast RT, Micro Perf with Cranial Flap
RT-1878KBOS-D2L	Fibreplast, Micro Perf with Cranial Flap
RT-1882BOS-D	Aquaplast RT, Standard Perf
RT-1882KBOS-D	Fibreplast, Standard Perf

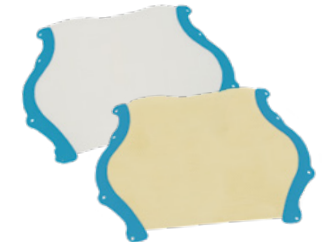

Head & Shoulders, 43 cm wide, 3.2 mm

RT-1878BOS-E2LS	Aquaplast RT (Small), Micro Perf with Cranial Flap
RT-1878KBOS-E2LS	Fibreplast (Small), Micro Perf with Cranial Flap
RT-1882BOS-ES	Aquaplast RT (Small), Standard Perf
RT-1882KBOS-ES	Fibreplast (Small), Standard Perf

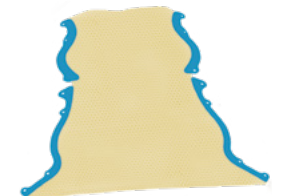

Head & Shoulders, 48 cm wide, 3.2 mm

RT-1878BOS-E2L	Aquaplast RT, Micro Perf with Cranial Flap
RT-1878KBOS-E2L	Fibreplast, Micro Perf with Cranial Flap
RT-1882BOS-E	Aquaplast RT, Standard Perf
RT-1882KBOS-E	Fibreplast, Standard Perf

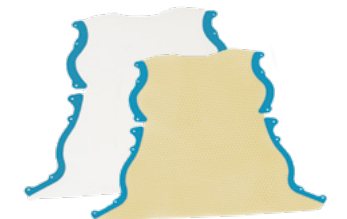

Measurement is taken at thermoplastics maximum width.

Universal Couchtop Long Extension

The Universal Couchtop is a modern and comprehensive solution for enabling advanced treatments in your clinic. Specifically designed to answer the demands of Proton, the Universal Couchtop Long Extension contains no rails or junctions in the treatment area to help facilitate better dose delivery and target coverage.

- Homogenous design for consistent treatment planning
- Utilizes Prodigy 2 indexing at 7 cm increments
- Low attenuation and surface dose
- Self-locking extension seam located outside of treatment field
- Compatible with many positioning and immobilization devices (see page 216)
- 5 Year Warranty



IBA Systems Proteus® ONE and Proteus PLUS

Includes Rectangular Extension (MTIL6673) and Prodigy 2 Lok-Bar. Large treatment area of 58.9" (149.7 cm).

MTIL6840	F-Series
MTIL6841	L-Series

Mevion Medical Systems S250™ Series

Includes Rectangular Extension (MTIL6660) and Prodigy 2 Lok-Bar. Large treatment area of 47.1" (119.7 cm).

MTIL7040	S250 Series
----------	-------------

Hitachi Ltd.

Compatible solutions available. Contact Hitachi for information.

Rectangular Extension

MTIL6673	64.9" (164.8 cm), square profile
MTIL6676	64.9" (164.8 cm), CT compatible
MTIL6660	53.1" (134.9 cm), standard profile
MTIL6684	53.1" (134.9 cm), square profile

See page 10 for LINAC and CT compatible Universal Couchtops

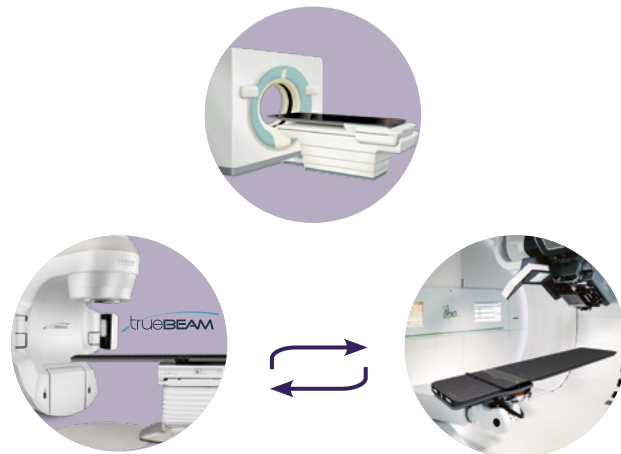

A universal platform for immobilization & positioning



ProForm Head & Neck Immobilization

The Universal Couchtop ProForm Head & Neck Extension features geometry that allows for direct access to effectively treat CNS patients. ProForm accepts a dedicated thermoplastic mask designed to meet the unique requirements of proton therapy.

- Homogeneous treatment area and soft gradient edges reduce beam degradation
- Head & Neck area provides fixed points that allow repeatable positioning and security of the AccuForm Cushion
- Thermoplastic mask attaches with a smaller profile frame and pin similar to the Type-S system



Extensions

MTIL6675K	ProForm Head & Neck Extension, 53.9" (136.9 cm), includes Cushion Guide and UCT Patient Handles
MTIL6683K	ProForm Head & Neck Extension, 64.9" (164.9 cm), includes Cushion Guide and UCT Patient Handles
MTIL6682K	Pediatric ProForm Head & Neck Extension, 48.7" (123.7 cm), includes Cushion Guide and UCT Patient Handles

Additional ProForm Extension lengths are available. Contact your sales representative for more information.

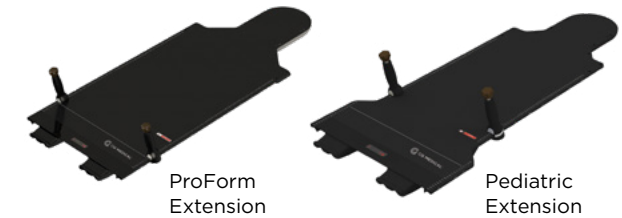

Overlays

The ProForm CT & Photon Treatment Overlay and MR Overlay allow for CT simulation or MR imaging of patients who will be treated on the Universal Couchtop ProForm Extension, allowing seamless transition from simulation to treatment.

PRO300K	ProForm CT & Photon Treatment Overlay, 2-Pin Lok-Bar compatible, includes ProForm Cushion Guide, Patient Handles and Table Strap
PRO320K	ProForm MR Overlay, 3-Pin Lok-Bar compatible, includes Cushion Guide and Patient Handles
PRO400K	Pediatric ProForm CT & Photon Treatment Overlay, 2-Pin Lok-Bar compatible, includes ProForm Cushion Guide and Patient Handles
PRO420K	Pediatric ProForm MR Overlay, 3-Pin Lok-Bar compatible, includes ProForm Cushion Guide and Patient Handles

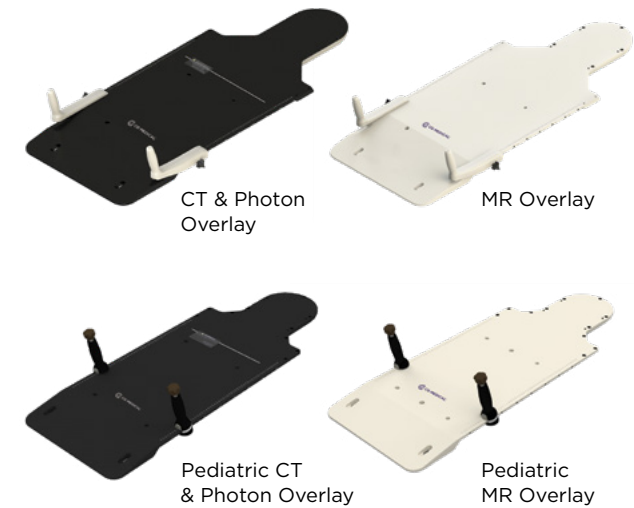

ProForm Thermoplastic

Masks are sold in boxes of 5 and are disposable. ProForm Thermoplastics are made from Aquaplast RT material.



FreedomView Reinforced Style 18

PRO330IM1832CL	Head Only, 3.2 mm
PRO331IM1832CL	Head, Neck & Shoulders, 3.2 mm
PRO331IM1832CLN	Head, Neck & Shoulders, Narrow

ClearVision 2

PRO330IM1832SG	Head Only, 3.2 mm
PRO331IM1832S	Head, Neck & Shoulders, 3.2 mm
PRO331IM1832SGN	Head, Neck & Shoulders, Narrow

Shoulder Thermoplastic Docking

Two shoulder docking options are available; standard top docking and underneath docking to accommodate for larger patients where additional stretching of thermoplastic may be required.

Not available for pediatric.



ProForm Thermoplastic

Masks are sold in boxes of 5 and are disposable. ProForm Thermoplastics are made from Aquaplast RT material.



Reinforced Style 18

PRO330IM1832	Head Only, 3.2 mm
PRO331IM1832	Head, Neck & Shoulders, 3.2 mm
PRO331IM1832N	Head, Neck & Shoulders, Narrow

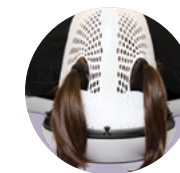

Reinforced Style 18 with Hair Openings

PRO330IM1832PT	Head Only, 3.2 mm
----------------	-------------------

Standard Perforated

PRO330	Head Only, 3.2 mm
--------	-------------------

Solid With Perforated Nose

PRO330SPN32	Head Only, 3.2 mm
-------------	-------------------

Registration Film

PRO340	Qty 5
--------	-------

AccuForm Cushion

MTACL2035	20 x 35 cm Chamfered, Qty 1
-----------	-----------------------------

Pediatric ProForm Thermoplastics

Masks are sold in boxes of 5 and are disposable. ProForm Thermoplastics are made from Aquaplast RT material.



FreedomView Reinforced Style 18

PRO430IM1832CL Pediatric Head Only, 3.2 mm

PRO431IM1832CL Pediatric Head, Neck & Shoulders, 3.2 mm



ClearVision 2

PRO430IM1832SG Pediatric Head Only, 3.2 mm

PRO431IM1832SG Pediatric Head, Neck & Shoulders, 3.2 mm



Pediatric ProForm Thermoplastics

Masks are sold in boxes of 5 and are disposable. ProForm Thermoplastics are made from Aquaplast RT material.



Reinforced Style 18

PRO430IM1832 Pediatric Head Only, 3.2 mm

PRO431IM1832 Pediatric Head, Neck & Shoulders, 3.2 mm



Standard Perforated

PRO430 Pediatric Head Only, 3.2 mm

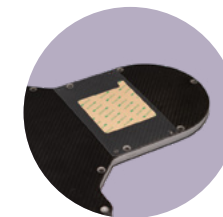

Registration Film

PRO440 Pediatric, Qty 5



AccuForm Cushion

MTACL2035 20 x 35 cm Chamfered, Qty 1

BoS AirShuttle for use with Symphony AirDrive System

A Symphony solution combines an AirShuttle positioning & transfer device with an AirDrive system to provide smooth patient transfers for imaging and treatment applications. Designed for proton therapy, the conformal shape of the BoS AirShuttle optimizes the penumbra and minimizes the blockage of important proton beam angles. When utilized alongside the Symphony AirDrive System, it facilitates seamless patient transfers for imaging and treatment procedures.

- Safely transfer your patient with minimal clinical staff
- Transfer on and off a wide variety of surfaces including sheet-covered pads and mattresses
- Patient positioning can include immobilization, where required
- Suitable for use in MRI
- Designed for proton therapy, the conformal shape of the device optimizes the penumbra and minimizes the blockage of important proton beam angles

See page 29 for AirDrive Systems

RT-5100-04 BoS AirShuttle

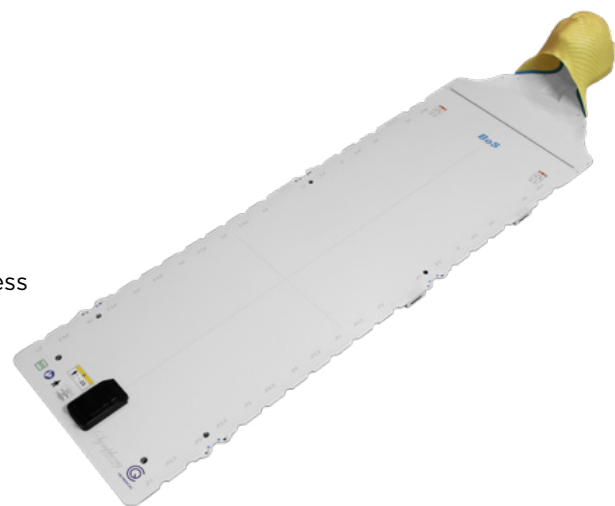

BoS AirShuttle Packages

Both packages include: AirShuttle Transfer Handles (x2), AirShuttle Locating Bars (x2), BoS Air Bearing (Spare)

RT-5100-400 w/ AirDrive Trolley

RT-5100-400S w/ AirDrive Caddie



AirDrive Trolley



AirDrive Caddie



kVue Portrait Proton System

Portrait Proton Insert

The kVue Portrait Proton insert is ideal for proton craniospinal radiotherapy treatments where whole brain lateral fields are combined with PA spine fields.

- Homogeneous, carbon fiber design provides constant WET from cranium to sacrum
- Compatible with Type-S Head Only and Head and Shoulder thermoplastic masks (see pages 92-98)

RT-4552KV-01 Portrait Proton Insert



Portrait Accessory

RT-4525HGA Hand Grips, Pair

RT-4492U AccuForm U Head Cushion, 20 x 35 cm, Qty 1

See page 102 Silverman Head Support Q Series



Q1



Q2



Q3



Q4



Additional ProtonSeries Positioning Devices

HEAD & NECK



GrayDuck
Oral Positioning
Stents
Page 113

BREAST & THORAX



C-Qual M with
Monarch Overhead
Arm Positioner
Page 130

LUNG & ABDOMEN



Body Pro-Lok ONE
Respiratory Belt
Page 49

HIP & PELVIS

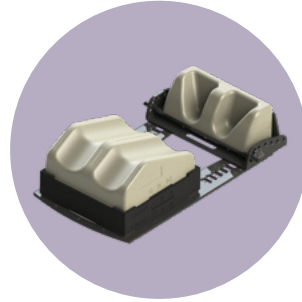

Combifix 3
Page 153

PATIENT CUSHIONS



Vac-Lok Cushions
Pages 160 & 161

FIDUCIAL MARKERS



PolyMark and
PointCoil
Page 176

UCT ACCESSORIES



Universal Couchtop
Patient Handles
Page 13

Accessories, Aids & Storage



Bolus



Bolus

Bolus (Bolx® & Bolx II®) is made from a solid, tissue-equivalent gel. It will not sag, deform or run. Bolus is available “skinless”, or encased in a tough layer of thin plastic “skin”.



Unlimited Scissors

RT-4932

SIZE	THICKNESS	SKINLESS BOLUS	BOLUS W/ SKIN
30 x 30 cm	0.3 cm	-	31033030
	0.5 cm	32052	31052
	1.0 cm	32102	31102
	1.5 cm	32152	31152
	2.0 cm	32202	31202
30 x 50 cm	0.5 cm	-	31053050
	1.0 cm	-	31103050
15 x 15 cm	0.5 cm	-	31051
	1.0 cm	-	31101
	1.5 cm	-	31151
40 x 40 cm	0.5 cm	-	31054040
	1.0 cm	-	31104040

Thermoplastic Sheets & Pellets

visionrt COMPATIBLE

Aquaplast RT Thermoplastic Sheets & Adapt-It Thermoplastic Pellets

Used for hard-to-form areas such as: chest wall, nose, parotid, groin, ears, and any irregularly surfaced anatomical feature. The attenuation characteristics are comparable to other polymer-based products. Both products soften in hot water or RapidHeat Oven. It reduces setup time and minimizes air gaps and day-to-day variability. Thermoplastic Sheets are available in a wide variety of additional sizes and thicknesses. See Vision RT's compatibility statement on back cover.



RT-1910-4	Thermoplastic Sheet, 4.8 mm, 200 mm x 230 mm
RT-1913-2	Thermoplastic Sheet, 2.4 mm, 300 mm x 300 mm
RT-1913-3	Thermoplastic Sheet, 3.2 mm, 300 mm x 300 mm
RT-1913-4	Thermoplastic Sheet, 4.8 mm, 300 mm x 300 mm
RT-1922	Thermoplastic Sheet, 4.8 mm, 450 mm x 600 mm
RT-1931-4	Thermoplastic Sheet, 4.8 mm, 300 mm x 450 mm
RT-7001	Adapt-It Thermoplastic Pellets, 1 lb. bag
RT-7003	Adapt-It Thermoplastic Pellets, 3 lb. bag

Pellet Bowl

Ideal for heating the desired amount of Adapt-It Thermoplastic Pellets in either a hot air oven or water bath.

The compact and lightweight bowl can hold approximately ½ lb of pellets and can be fully expanded to 2" height or 0.5" when collapsed flat.



RT-2075-PB Pellet Bowl (125 ml, 1/2 cup)

Quality Assurance

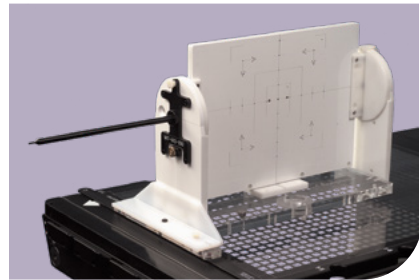

Iso-Align™

The Iso-Align is a multi-purpose quality assurance device designed to assist in the routine secondary verification of linear accelerators and room lasers. The Iso-Align accommodates a convenient film pack for radiation and light field verification. The Iso-Point Rotational Runout Tool on the Iso-Align allows you to accurately and easily verify the mechanical isocenter of the gantry. In addition, the Iso-Align can be used to verify multiple aspects of linear accelerators and room lasers, including:

- Alignment of all lasers
- Collimator and table/couch rotational angle readout accuracy
- Light field alignment and jaw readout accuracy
- Mechanical isocenter of collimators and treatment tables/couches
- Optical Distance Indicator (ODI) accuracy at various distances
- Port film grid alignment
- Radiation and light field coincidence at various gantry angles
- Radiation isocenter of collimators, gantries, and treatment tables/couches

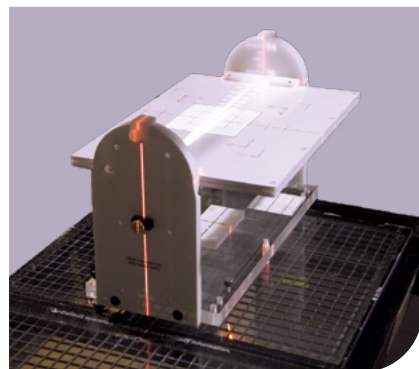

MTIAD1

TG66 CT Simulation Laser QA Device

This unique device is used to complete secondary specific quality assurance checks of CT scanners and room lasers, in accordance with the recommendations of AAPM's TG66. Easily indexed to the CT table, this clearly-marked tool helps perform an array of important QA checks, including:

- Alignment of gantry lasers
- Spacing and orientation of room lasers
- Confirmation of a level and orthogonal table orientation

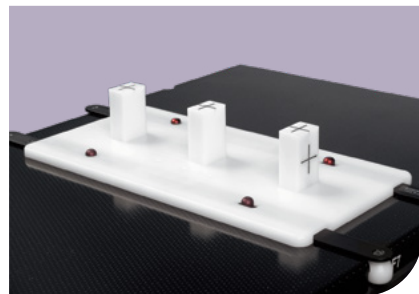

MTTG66 Requires (Qty 2) Two-Pin Lok-Bar or Locating Bar

Accessories & Aids



Testicle Shields

Testicle Shields are designed to reduce scatter radiation to the testicles. Each unit is cast to provide a lead wall with a thickness of ½" (1.27 cm) and features an open sector to allow comfortable attachment to the patient. All surfaces are coated with a polyurethane paint.

The shield's top and bottom sections are secured with either the two included rubber straps or nylon tape. When using the testicle shield stand, no straps are needed.

THESE PRODUCTS HAVE NOT BEEN CE MARKED

MTTSS Small, Qty 1

MTTSM Medium, Qty 1

MTTSL Large, Qty 1



Testicle Shield Stand

This adjustable stand offers increased patient comfort while raising or lowering the shield. A manual adjustment knob allows for easy vertical positioning from 1-10" (2.54-25.4 cm). The stand can be used for anterior and posterior treatments.

THIS PRODUCT HAS NOT BEEN CE MARKED

MTTSST2

Grip Rings™

Grip rings offer patients an extra measure of security and comfort. The tough blue vinyl is smooth and easy to wipe clean with most antibacterial solutions. Grip Rings are sold individually and in sets.

THIS PRODUCT HAS NOT BEEN CE MARKED

MTVIP181 Grip Ring Small (Children and Small Adults, 3" inside diameter)

MTVIP182 Grip Ring Medium (Average-Sized Adult Hands, 4.25" inside diameter)

MTVIP183 Grip Ring Large (Large Adult Hands and Adult Feet, 6" inside diameter)

RT-4487G-083 Grip Ring X-Large (Large Feet or Feet with Shoes)

MTVIP166 Grip Ring Set of 3 (3, 4.25 and 6" inside diameter)

MTVIP1664 Grip Ring Set of 4 (3, 4.25, 6 and 8" inside diameter)



Accessories & Aids



Setup Rulers

Great aid to help with the setup of patients. These rulers start at "0" from the edge and the unit of measurement is millimeters. For reference only.

CQRULER Qty 1

ALRA Skin Care

This special line of skin care products is designed to provide gentle, effective care for patients undergoing radiation therapy.

The moisturizer contains aloe vera, lanolin, Vitamin E, collagen and allantoin. It is fragrance-free. Unlike regular antiperspirants, the ALRA deodorant stick contains no metallic ingredients that can interfere with radiation. It contains the natural astringent cypress oil and the natural bactericide lichen. Patients can order ALRA products directly from us (North America only).

THESE PRODUCTS HAVE NOT BEEN CE MARKED



MTCBALRASL4 Therapy Lotion, 4 oz

MTCBALRAD Non-Metallic Deodorant

Table Strap

The Table Strap ensures patient control, safety and comfort with a strong material that feels soft to the touch. The Table Strap features a two-way adjustable fastener made of double-faced Velcro® brand loop. It can be washed and sterilized. Individually packaged. 4" wide x 72" long.

THIS PRODUCT HAS NOT BEEN CE MARKED



MTVIP173

Accessories & Aids



Incontinence Clamps

THESE PRODUCTS HAVE NOT BEEN CE MARKED

MTVIPU414R Cunningham Clamp, Regular

MTVIPU414L Cunningham Clamp, Large

MTVIPU413 Zipser Clamp (right photo)



Patient Transfer Board

The Patient Transfer Board is designed to ease patient transfer from a bed or stretcher to a treatment table with minimum effort. The board is constructed of a durable polyethylene material.

THIS PRODUCT HAS NOT BEEN CE MARKED

MTVIP40



Calipers

Body Calipers can be used for tabletop distances to determine central-axis and off-axis measurements. The reversing caliper orientation assists in determining separations such as laterals, obliques and off-table measurements. The wide base ensures perpendicularity to tabletop. A color-coded scale on both sides eliminates confusion with scale orientation.

It is made of precision-machined aluminum with a gold-tone finish. Components are hand-tapped, counterbored and assembled with steel screws for strength and stability. The easy-to-read screen-printed scale is protected from wear by a recessed sliding scale indicator.

THESE PRODUCTS HAVE NOT BEEN CE MARKED

MTBC45 Body Caliper, 45 cm

MTBC55 Body Caliper, 55 cm

Storage Solutions



Wall Mount

Designed to store your Alta, QUANTUM CT Overlay, DoseMax, Low-e, Access Supine Breast Device, AccuFix Head & Neck Device, and Portrait Intracranial, Head & Neck Device.

RT-4543WALL



Wall Mount shown with compatible devices



Overlay Stand

The Overlay Stand is ideal for shared CT rooms, where space is limited. The Overlay Stand creates a fast and effective way to store and protect your CT overlay between uses. The base and strap plate easily mount to the wall, allowing for quick access and out-of-the-way storage. Upper straps secure the overlay between uses.

MTIL1104

Universal Couchtop Long Extension Storage Device

MTIL6000SU For up to four long extensions

MTIL6100SU For one long extension (included in UCT LE package)



Storage Solutions



Combifix Wall Storage

013115 not for use in MR environment



Bellyboard Wall Storage

Compatible with the Carbon Fiber Bellyboard and MRSeries Bellyboard

013140



Head, Neck & Shoulders Baseplate Storage

Two-Pin Baseplate Storage, compatible with two-pin Posifix and Posirest baseplates and most other two-pin ready baseplates

013159



C-Qual & Evolve Breastboard Wall Storage Device

A convenient wall-mounted rack is available for C-Qual M, C-Qual, and Evolve breastboard storage.

013156



ONEBridge Storage Base

Holds the ONEBridge in an upright position. Designed to sit on a countertop or cart.

BPL005



Vac-Lok Storage Rack

This space saving rack holds molded & inflated cushions. Plastic "S" hooks are available for hanging cushions.

MTVL401 Storage Rack, Double Wide

MTVL402 Casters for MTVL401, Qty 4

MTVLHOOK "S" Hooks, Qty 10

Storage Solutions



Storage Cart

Great option for storing kVue inserts, Encompass, Portrait, BoS, Access 360, DoseMax, and Low-e inserts.

RT-4551CART Storage Cart has four sections to hold multiple devices



Mobile Accessory Cart

This accessory cart has been specially designed to hold a wide variety of patient positioning and fixation devices. The cart can hold up to 300 lbs (135 kg) and measures 40⁵/₈ x 20 x 37¹³/₁₆" (103.2 x 50.8 x 96 cm). An optional storage bin is available for storing smaller items.

MTMC020 Mobile Accessory Cart

20MC02005 Storage Bin



Dry Heat Oven/Waterbath Stand **NEW!**

The stainless-steel Dry Heat Oven/Water Bath Stand is an efficient way to store or transfer a dry heat oven or water bath in and between treatment rooms. The stand can be changed to a mobile cart by assembling a set of four lockable casters.

Dimensions (W x D x H)

Without Casters: 36 x 30 x 24" (91.44 x 76.2 x 60.96 cm)

With Casters: 36 x 30 x 28" (91.44 x 76.2 x 71.12 cm)

Load Capacity

Without Casters: 750 lbs / 340 kg

With Casters: 500 lbs / 226 kg

Bottom Shelf: 175 lbs / 79 kg

RT-2111C Dry Heat Oven/Water Bath Stand

RT-2111C-WLS Lockable Casters (shown, sold separately), Qty 4

A

ABS Reloadable Type-S Frame Only **90**

Accessory Ladder Set **136**

Access Prone G2 Breast Device **141,142**

Access Supine **133**

AccuForm Cushions **115,211,213**

Accusyte **180**

Acrylic Supine Baseplate

Uni-frame **100**

Adapters **121**

AirShuttle & AirDrive **29**

Align Markers **178**

Alpine Stirrups **39**

ALRA Skin Care **222**

Alta AirShuttle **32**

Alta for Pelvis **150**

Alta Multipurpose Device **41,42**

Aquaplast RT **84**

Aquaplast RT Aqua-Brief **150,151**

ArmShuttle Elite **134**

Arm Supports

Arm & Wrist Supports **134**

Monarch Overhead Arm Positioner **131**

Wing Boards **144**

B

Bellyboards

Carbon Fiber **153**

MRSeries **153**

SofTouch Elite **156**

Storage **225**

BioXmark Liquid Fiducial Marker **181**

Body Calipers **223**

Body Pro-Lok ONE **49**

Bolus **218**

Bone Markers **178**

BoS AirShuttle **33**

BoS Thermoplastics **206,207**

BrachyGel **36**

Breastboards

Access Prone G2 Breast Device **141**

Access Supine & Access Supine MR **133**

C-Qual **132**

C-Qual M **130**

Evolve **137**

kVue Access 360 G2 Prone Breast Insert **139**

New Horizon Prone **143**

Thorawedge **143**

Breast Support Thermoplastic **130**

Breast & Thorax Vac-Lok Cushions **162**

C

Calipers **223**

Carbon Fiber Bellyboard **153**

Carbon Fiber Supine Baseplate

Posifix **105,225**

Uni-frame **100**

Chamfered AccuForm **115**

Chin Strap Thermoplastic **108**

Clam-Lok Cushion **58**

ClearVision 2 **210,212**

ClearVision Thermoplastic **95,102**

Combifix 3 **153**

Comfort Marker 2.0 **183**

Couchtops **10,11,12,13,14**

Couchtop Service Panel **14**

Couchtops & Overlays **6**

Coupled Markers **177**

C-Qual Breastboard **132**

C-Qual M Breastboard **130**

C-Qual Wall Storage Device **225**

CT Overlays **20**

Customizable Head Support **114**

CyberMark Markers **178**

D

DecoColor Markers **189**

Direct Indexing Adapters **121**

Disposable Rectal Markers **188**

Disposable Vaginal Markers **188**

Dry Heat Oven/Waterbath Stand **122,226**

E

Elekta Unity Lok-Bar **191**

Elevation Blocks **60**

Encompass SRS Immobilization System **70,71,72,77**

End Plate for Varian **13**

Evolve Breastboard **137**

Exact Lok-Bar **22**

Extended Head Stop Headrests **118**

Extended Wing Board **144**

F

Feetfix 3 **60,155**

Fibreplast **84**

Fiducial Markers

Accusyte **180**

Align Markers **178**

Bone Markers **178**

Coupled Markers **177**

CyberMark Markers **178**

FlexiCoil Markers **177**

FlexiMarc G/T Markers **177**

FusionCoil Markers **175**

Gold Soft Tissue Markers **179**

PointCoil Markers **176**

PolyMark Markers **176**

Suture-Type Markers **178**

Fixator **90**

FlexiCoil Markers **177**

FlexiMarc G/T Markers **177**

FlexLock Knee & Foot Supports **152**

Foam Positioners **172**

FreedomView Reinforced Style 18 **210,212**

FusionCoil Markers **175**

G

Gold Soft Tissue Markers **179**

GrayDuck Stents **113**

Grid Long Extension **11**

Grip Rings **221**

H

Headboards **99**

Head, Neck & Shoulders Baseplates

105,225

Head & Neck Vac-Lok Cushions **163**

Headrests

AccuForm **115**

Adapters **121**

Customizable Head Support **114**

Extended Head Stop Headrests **118**

Posifix Contoured Headrests **119**

Posifix Pediatric Headrests **119**

Posifix Prone Headrest **119**

Posifix Supine Headrests **118**

Posifix Wide Headrest **119**

Prone Head Cushion & Adapter **120**

Silverman Headrests **117**

Timo Headrests **118**

Helping Hands **168**

HipFix Immobilization System **148**

Thermoplastics **149**

Hip & Pelvic Vac-Lok Cushions **163**

I

iBEAM Overlay Adapter **90,105**

Index

I.D. Tags **168**
IMRT Reinforced Thermoplastics
Breast Support **130**
HipFix **149**
Incontinence Clamps **223**
InfinityLock Bridges & Paddle **63**
InfinityLock Hand Grips **204**
InfinityLock™ Hand Grips **204**
InkAlign **184**
INSIGHT **192**
IntegraBite **116**
Integrated Shim **91**
Integrated Shim Thermoplastics **92**
Interloc Lok-Bar **22**
Iso-Align **220**

K
Kneefix 3 **60,155**
kVue Access 360 G2 Prone Breast
Insert **18,139,140**
kVue BoS Proton System **205**
kVue Couchtop **14**
kVue CT Overlay **14**
kVue Insert Docking Plate **14**
kVue Inserts **16,17,19,64**
kVue One Couchtop **15**
kVue One Proton Couchtop
202,203,204
kVue Portrait Proton System **215**
kVue Pronumbra Head & Neck System
203
kVue Proton Couchtop **202**
kVue Virtual Indexing **19**

L
Lateral Baseplate **100**
Leg Roll Positioner **171**
Lithotomy AirShuttle **31,38**
Locating Bars **24**
Locking Locating Bar **204**
Lok-Bars **22,23,169**
Long Extension Storage Device **224**
L-Profile Thermoplastics **109**

M
Miscellaneous Thermoplastics **98,103**
Mobile Accessory Cart **226**

Monarch Overhead Arm Positioner
61,131
Monarch Thermoplastic Frame **131,132**
MRI Overlays **191,194**
MRI Type-S Overlay **90**
MR Lok-Bar **23,191**
MR Lok-Bar/Locating Bar **62**
MR Posi-S Adapter **89**
MRSeries Bellyboard **153**
MRSeries Positioning **196,197,198**
Multi Purpose Support Cushions **171**

N
New Horizon Prone Breastboard **143**
Non-Metallic Deodorant **222**

O
ONEBridge **49,58**
ONEBridge Storage Base **225**
ONE Respiratory Belt **59**
Overlay Board **90**
Overlays - CT **21**
Overlays - MR **191,194**

P
Patient Handles **13,62**
Patient Marking
Comfort Marker 2.0 **183**
DecoColor Markers **189**
InkAlign **184**
Portal Markers **187**
Rectal Markers **188**
Rulers **188**
Sharpie Markers **189**
Suremark Markers **185-188**
Vaginal Markers **188**
Patient Transfer Board **223**
Pediatric Masks **97,212,213**
Pediatric ProForm Thermoplastics
111,212,213
Pelvis Thermoplastics **149**
PointCoil Markers **176**
PolyMark Markers **176**
Portal Markers **187**
Portrait Head & Shoulder Thermoplastic
Adapters **135**
Portrait with Integrated Shim **91**

Posicast-Lite and Posicast-Plus
Thermoplastics **107**
Posicast-Lite & Posicast-Plus **84**
Posicast-Lite Thermoplastics **107**
Posicast Microperfo Plate **108**
Posifix Contoured Headrests **119**
Posifix Long Extension **12**
Posifix Pediatric Headrests **119**
Posifix Prone Headrest **119**
Posifix Supine Headrests **118**
Posifix System
Baseplates **105,106,107**
Extensions **104**
Posicast Thermoplastics **111,212,213**
Posifix Variable Axis Baseplate **105**
Posifix Thermoplastics **106-108**
Posifix Wide Headrest **119**
Precise Bite **116**
Prodigy 2 Lok-Bar **22**
Prodigy Lok-Bar **22**
ProForm **209**
Pediatric Extension & Overlays **110**
Thermoplastic **210-213**
Prone Head Holder **100**
Prone-Lok Cushion **154**
Prone Thorax Support **154**
Prone VacQfix Indexer **169**
Pron-Pillo Cushion **154**
Pronumbra Head & Neck System **203**
Pronumbra Neck Support **204**
Pronumbra Shoulder Adapters **204**
Pro Posifix Headrest Adapter **138**
Pro Wing Board **138**

Q
Quality Assurance **220**
QUANTUM CT Overlays **20**

R
Rapid Heat Oven **122**
RectalPro 75 Endorectal Balloon (ERB)
158
Rectal & Vaginal Markers **188**
Rectangular Long Extension **11**
RediFoam **171**
Registration Film **211,213**
Reinforced Style 18 **211,213**

Index

Reinforced Style 18 with Hair Openings **211**
Reinforcement Thermoplastic Strips
98,103
Respiratory Plate **49**
Respiratory Plate, Standard **58**
Respiratory Plate, Wide **58**
Rulers **188,222**

S
SBRT Customization **58,59,60,61,62**
Sharpie Markers **189**
Shims **117**
Shoulder Retractor **114,120**
Shoulder Support Cushion **171**
Shoulder Thermoplastic **75,95,108**
Silverman Adapter for Breast Devices &
ArmShuttle **136**
Silverman Headrests **117**
Skinless Bolus **218**
Slate AirShuttle **33**
Slide Guide Lok-Bar **23,62**
SofTouch Couchtop Pads **25**
SofTouch Elite Bellyboard **156**
Soft Tissue Gold Markers **179**
Solid With Perforated Nose **211**
Solstat Immobilization System **112**
Solstice SRS Immobilization System
73,74,75
Spacers **120**
Spacers & Wedges **120**
Split-Leg Vac-Lok **148**
SRS Adapter **76**
Standard Perforated **211,213**
Standard Perforation Thermoplastics
Breast **130**
HipFix **149**
Standard Respiratory Plate **58**
Standard Wing Board **144**
Storage Solutions **224-226**
Suremark Markers **185-188**
Suture-Type Markers **178**
Symphony Patient Transfer System **28**

T
Table Strap **222**
Testicle Shields **221**
Testicle Shield Stand **221**

TG66 CT Simulation Laser QA Device **220**
Therapy Lotion **222**
ThermFix Immobilization System **148**
Thermoplastics **149**
Thermoplastic Breast Adapter **135**
Thermoplastic Chin Strap **135**
Thermoplastics
L-Profile Thermoplastics **109**
Pediatric ProForm **111,212-213**
Posifix Thermoplastics **106-108**
ProForm Thermoplastic **210-213**
Type-S Thermoplastics **92-98**
Uni-frame Thermoplastics **101-103**
Thorawedge **143**
Tilt-Pro Tilting Base **99**
Timo Headrests **118**
TotalRT All in One Platform **44,45**
Transverse Lok-Bar **23,62**
Treatment Brassiere **145**
T-Shape Vac-Lok **60,161**
Type-S Long Extension **12**
Type-S System
Baseplates **89**
Extensions **87**
Fixator **90**
iBEAM Overlay Adapter **90**
MRI Type-S Overlay **90**
Overlay Board **90**
Overlays **89,90**
Platforms **88**
Standard Perforation **97**
Thermoplastics **92-98**
Universal Couchtop Long Extension **87**
Variable Axis Baseplate **89**
Varian Style Extension **87**
Type-S Thermoplastics **92-98**

U
Uni-frame System
Baseplates **99,100**
Lateral Baseplate **100**
Prone Head Holder **100**
Thermoplastics **101,103**
Tilting Baseplates **100**
Uni-frame Thermoplastics **101-103**
Universal Couchtop 1 Piece **10**
Universal Couchtop Accessories **13**

Universal Couchtop Head Extension **13**
Universal Couchtop Long Extension
10,11,12,13

V
Vac-Lok Cleaner **168**
Vac-Lok Cushions
Breast & Thorax **162**
Head & Neck **163**
Helping Hands **168**
Hip & Pelvic **163**
Non-Rectangular **161**
Rectangular **160**
Storage Racks **168,225**
Vac-Lok Storage Racks **225**
VacQfix Cushions **60,164,165,166,167**
VacQfix Indexer **169**
Vacuum Compressors **170**
Vaginal Markers **188**
Variable Axis Baseplate **89,105**
Varian Style Extension **87,104**
Virtual Indexing **19**

W
Warmer **123**
Water Baths **123**
Wedges **120**
Wide Respiratory Plate **58**
Wing Boards **144**
ArmShuttle Elite **134**
Monarch Overhead Arm Positioner **131**
Pro Wing Board **138**

Z
ZENTEC Thermoplastics **84,96**
ZiFix Traverse **59**

Part Number Index

20CFHNPSUBIP	97	301052	60,155	BPL120	58
20CFHNSUBIP	90	301055	60,155	BPL300	57
20CFHNSUB2	90	301056	155	CHS01	114
20CFHNSUB7	90	301071	60,155	CHS02	114
20MCO2005	226	301076	154	CHS03	75,112
20VARSUB10	22	301080	143	CHS03K	74
013115	225	301081	143	CHS03MR	75
013140	153,225	301082	143	CHS03MRK	74
013156	225	301102	154	CHS03MRSGK	74
013159	105,225	301201	118	CHS03SGK	74
31051	218	301202	118	CHS04	75,112
31052	218	301203	118	CHS04K	74
31101	218	301204	118	CHS04MR	75
31102	218	301205	118	CHS04MRK	74
31151	218	301234	119	CHS04MRSGK	74
31152	218	302071MR	153	CHS04SGK	74
31202	218	302072	153	CHS05	112
32052	218	305001	118	CHS06	112
32102	218	400006	171	CHS40	112
32152	218	402422	171	CHS40K	112
32202	218	402525	171	CHS41	112
101019	105	402820	171	CHS42	112
102021	105	402848	171	CQRULER	188,222
107063	157	403024	171	GDS001	113
107065	105	772021	108,131	GDS002	113
107101MR	120	772030	107	GDS003	113
107102MR	120	772044	107	MPCM2010	183
107103MR	120	772145	107	MPCM2010INT	183
107104MR	120	924392	108	MPCM4022	183
107106MR	120	930030	107	MPCM4022INT	183
108010	104	930033	107	MT202	100
108072	105	930044	107	MT400	132
108073	90	930055	107	MT401	132
125012	153	930080	157	MT20100	100
126000	153	930145	107	MT20100CF	100
151004MR	153	970031	107,131	MT20103CF	100
151005MR	153	8003020	134	MT20104	100
301008A	119	8003415	170	MT20108	100
301022	119	11210590	181	MTACL001	115
301023	119	31033030	218	MTACL1520	115
301024	119	31053050	218	MTACL2035	
301025BLK	89,119	31054040	218		75,112,114,115,204,211,213
301026	119	31103050	218	MTACL2035HF	
301027A	119	31104040	218		75,112,114,115,204
301029	121	BPL001	58	MTACL2035U	115
301030	118	BPL005	225	MTACL2045	115
301032	118	BPL007	58	MTACL4060	115
301033	118	BPL008	58	MTACL5865T	115
301034	118	BPL009	58	MTACL6060	115
301035	89,121	BPL010	57	MTACL14242	115
301040	171	BPL020	57	MTACLSHIM	115
301048	155	BPL026	59	MTACLTPES1	115

MTACLTPES2	115	MTAPUIR1832	98
MTAPCID1832	75,112	MTAPUIW1824VT	102
MTAPCID1832SG	71,75,112,195	MTAPUIW1832VT	102
MTAPCIN1832	75,112	MTAPUL	100
MTAPCIN1832SG	75,112	MTAPUL2.4	100
MTAPS3.2	98	MTAPUR	98
MTAPS25	98,103	MTAPUR2.4	98
MTAPS35	98,103	MTAPUW	103
MTAPSI8391	98,103	MTAPUW2.4	103
MTAPSD2.4	97	MTAPUW122.4	103
MTAPSD3.2	97	MTBC45	223
MTAPSID27NR24	96	MTBC55	223
MTAPSID27NR32	96	MTBR100LL	145
MTAPSID29NR24	98	MTBR100LR	145
MTAPSID29NR32	98	MTBR100ML	145
MTAPSID2724	96	MTBR100MR	145
MTAPSID2724VT	96	MTBR100SL	145
MTAPSID2732	96	MTBR100SR	145
MTAPSID2732SG	95	MTBR100TBC	145
MTAPSID2732VT	96	MTBR100XLL	145
MTAPSID2924	98	MTBR100XLR	145
MTAPSID2932	98	MTCB36	154
MTAPSP2.4	97	MTCBALRAD	222
MTAPSSPF	75,95,108	MTCBALRASL4	222
MTAPSSTS	75,95,112	MTCBPBITE	116
MTAPU	103	MTCBPBITES	112,116
MTAPU1.6	103	MTCBPBITETD	116
MTAPU2.4	103	MTCBPBITETDS	116
MTAPUI2	103	MTCBPBITEWRM	116,123
MTAPUI4	103	MTCBPFC	168
MTAPUI22.4	103	MTCBPLL	123
MTAPUI42.4	103	MTCFHN006	90
MTAPUD	97	MTCFHN006SUB6	90
MTAPUD002	98	MTCFHN	87
MTAPUD2.4	97	MTCFHN	VAB01 89
MTAPUD1224	98	MTCT23	186
MTAPUD1424	98	MTCT40	186
MTAPUI1824	102	MTCTCR3	186
MTAPUI1824VT	102	MTCTW10	186
MTAPUI1832	102	MTCTW20	186
MTAPUI1832CL	102	MTCTXFC001	175
MTAPUID1824	96	MTCTXFC105185	175
MTAPUID1824VT	96	MTCTXFC1051820	175
MTAPUID1832	96	MTCTXFC1051825	175
MTAPUID1832SG	95	MTCTXFC09101820	177
MTAPUID1832VT	96	MTCTXFC10201820	175
MTAPUID2024	98	MTCTXFC10251820	175
MTAPUID2032	98	MTCTXFC12101720	177
MTAPUID2232	98	MTCTXGT10182010	177
MTAPUID181232	98	MTCTXGT10182020	177
MTAPUID181332RD	96	MTCTXPC0605	176
MTAPUID181432	98	MTCTXPC08185	176

Part Number Index

MTCTXPC0819153	176	MTIL6042	10
MTCTXPM0834	176	MTIL6044	10
MTCTXPM101820	176	MTIL6045	10
MTCTXPM101825	176	MTIL6046	10
MTDLI2	157	MTIL6047	10
MTDLI2	157	MTIL6048	10
MTFA39B	171	MTIL6049	10
MTFA40B	171	MTIL6050	22,62
MTFA41B	171	MTIL6051	22,23,62
MTGBSUB1	144	MTIL6053	22
MTGBSUB3	144	MTIL6054	22,23,62,191
MTHFI1822	149	MTIL6058	23
MTHFI18222.4	149	MTIL6100SU	224
MTHFX1822	149	MTIL6120	10
MTHFX1822S	149	MTIL6121	10
MTHFX18222.4	149	MTIL6140	10
MTHFX18222.4S	149	MTIL6141	10
MTHPBBO1	143	MTIL6142	10
MTHPBBO103	143	MTIL6152	13
MTIAD1	220	MTIL6220	10
MTIL1006	23,169	MTIL6240	10
MTIL1104	224	MTIL6320	10
MTIL3013	21	MTIL6321	10
MTIL3019	21	MTIL6322	10
MTIL3020	21	MTIL6323	10
MTIL3051	22	MTIL6341	10
MTIL3151	21,22	MTIL6342	10
MTIL3152	21,23	MTIL6343	10
MTIL3300	21	MTIL6420	10
MTIL3310	21	MTIL6440	10
MTIL3311	21	MTIL6520	10
MTIL3351	23,191	MTIL6521	10
MTIL3352	23,191	MTIL6540	10
MTIL3454	23,191,194	MTIL6541	10
MTIL3651	22	MTIL6612	13
MTIL3652	23	MTIL6617	13
MTIL3653	21,22	MTIL6660	11,208
MTIL3704	21	MTIL6661	11
MTIL3705	21	MTIL6663	11
MTIL3850	22	MTIL6664	12,87
MTIL3950	23	MTIL6665	12,87
MTIL4101	21	MTIL6666	12,104
MTIL6000SU	224	MTIL6667	13
MTIL6020	10	MTIL6669	11
MTIL6022	10	MTIL6670	12,87
MTIL6023	10	MTIL6672	12,104
MTIL6024	10	MTIL6673	11,208
MTIL6026	10	MTIL6675K	12,209
MTIL6027	10	MTIL6676	11,208
MTIL6028	10	MTIL6682K	12,209
MTIL6029	10	MTIL6683K	209
MTIL6040	10	MTIL6684	208

MTIL6840	208	MTIL6840	208
MTIL6841	208	MTIL7040	208
MTIL662501	13,62	MTIL662502	13,62
MTLTBP	100	MTLTBP2	100
MTLTBP2	100	MTLTBPIAT01	100
MTM400	130	MTM500	138
MTM3002	194	MTM3003	194
MTM3004	191	MTM3302	194
MTM3404	194	MTMCO20	226
MTMCRHNP	90	MTMRHNTYPES	90
MTNW887709	177	MTNW887710	177
MTNW887711	177	MTNW887712	177
MTNW887805	178	MTNW887808	179
MTNW887809	179	MTNW887812	179
MTNW887825	179	MTNW887825	179
MTNW887830	179	MTNW887830	179
MTNW887835	179	MTNW887835	179
MTNW887836	179	MTNW887836	179
MTNW887837	179	MTNW887837	179
MTNW887840	179	MTNW887840	179
MTNW887851	178	MTNW887851	178
MTNW887853	178	MTNW887853	178
MTNW887855	178	MTNW887855	178
MTNW887860	179	MTNW887860	179
MTNW887866	178	MTNW887866	178
MTNW887870	179	MTNW887870	179
MTNW887871	179	MTNW887871	179
MTNW887872	179	MTNW887872	179
MTNW887873	179	MTNW887873	179
MTNW887881	178	MTNW887881	178
MTNW887882	178	MTNW887882	178
MTNW887883	178	MTNW887883	178
MTPFC02	89	MTPFC02	89
MTPLC01	154	MTPLC01	154
MTPLHA01	149	MTPLHA01	149
MTPLHA0201	149	MTPLHA0201	149
MTPLHA0202	149	MTPLHA0202	149
MTPLHA0203	149	MTPLHA0203	149
MTPLVCO4MR	148	MTPLVCO4MR	148
MTPLVCSUB8	149	MTPLVCSUB8	149

Part Number Index

MTPM150 **187**
MTPM350 **187**
MTRFH3 **130**
MTRFI918 **130**
MTRFI9182.4 **130**
MTRFX918 **130**
MTRFX9182.4 **130**
MTRHI500 **123**
MTRHI500EX **123**
MTSBRT003 **58**
MTSBRT202 **58**
MTSHIM01 **117**
MTSHIM01S **117**
MTSHIMS **117**
MTSHIMT **89,117**
MTSILVER2 **117**
MTSILVER2A **117**
MTSILVER2B **117**
MTSILVER2C **117**
MTSILVER2D **117**
MTSILVER2E **117**
MTSILVER2F **117**
MTSL10 **185**
MTSL15 **185**
MTSL15T **185**
MTSL20 **185**
MTSL20T **185**
MTSL25 **185**
MTSL25RT **187**
MTSL30 **185**
MTSL40 **185**
MTSLCL20 **187**
MTSLCL25 **187**
MTSLLM1 **186**
MTSLLM2 **186**
MTSLV20 **186**
MTSLV30 **186**
MTSLV40 **186**
MTSLV50 **186**
MTSLW3 **185**
MTSLW4 **185**
MTSLW8 **185**
MTSR01 **114**
MTSR02 **114**
MTSR03 **114**
MTSRP104 **180**
MTTG66 **220**
MTTIMO2 **118**
MTTIMO2A **118**
MTTIMO2B **118**
MTTIMO2C **118**
MTTIMO2D **118**
MTTIMO2E **118**
MTTIMO2F **118**
MTTIMO2L **118**
MTTSL **221**
MTTSM **221**
MTTSS **221**
MTTSS2 **221**
MTULB001 **23,191**
MTULB002 **191**
MTVAR46 **23**
MTVIP40 **223**
MTVIP166 **221**
MTVIP173 **222**
MTVIP181 **221**
MTVIP182 **221**
MTVIP183 **221**
MTVIP1664 **221**
MTVIPFFF101C **172**
MTVIPFFF102C **172**
MTVIPFFF105C **172**
MTVIPFFF106C **172**
MTVIPFFF801C **172**
MTVIPFFF802C **172**
MTVIPFFF803C **172**
MTVIPFFF804C **172**
MTVIPU413 **223**
MTVIPU414L **223**
MTVIPU414R **223**
MTVL71FC **148**
MTVLHH150 **168**
MTVLHOOK **168,225**
MTVLTAG **168**
MTVPI **170**
MTVPEXA **170**
MTVPEXC **170**
MTVPEXD **170**
MTVPEXG **170**
MTVPEXH **170**
MTVPFT **170**
MTVRT20 **95**
MTVRTW **102**
MTWB08T **144**
MTWB08U **144**
MTWB09 **144**
MTZM1710 **188**
MTZM1735 **188**
MTZM1740 **188**
OAPI00 **132**
OAPI10 **61,131**
OAPI20 **131,132**
OAPI21 **138**
OAPI40 **138**

OAPI60 **131**
OAPI70 **131**
OAPI80 **131**
OAP200 **138**
OAP220 **61**
OAP221 **131**
OAP223 **138**
OAP224 **138**
OAP240 **138**
OAP300 **138**
PRO300K **209**
PRO320K **209**
PRO330 **211**
PRO330IM1832 **211**
PRO330IM1832CL **210**
PRO330IM1832PT **211**
PRO330IM1832SG **210**
PRO330SPN32 **211**
PRO331IM1832 **211**
PRO331IM1832CL **210**
PRO331IM1832CLN **210**
PRO331IM1832N **211**
PRO331IM1832S **210**
PRO340 **211**
PRO400K **209**
PRO420K **209**
PRO430 **213**
PRO430IM1832 **111,213**
PRO430IM1832CL **111,212**
PRO430IM1832SG **111,212**
PRO431IM1832 **111,213**
PRO431IM1832CL **111,212**
PRO431IM1832SG **111,212**
PRO440 **111,213**
PRO450 **111,213**
PRO3311832SGN **210**
RT-1500-04 **214**
RT-1776KSDGXF **93**
RT-1776KYS DGXF **93**
RT-1778KFORF3 **109**
RT-1778KFORF5 **109**
RT-1778KORF3 **109**
RT-1778KORF5 **109**
RT-1778KPR3D **106**
RT-1778KPR3DF **106**
RT-1778KPR5D **106**
RT-1778KPR5DF **106**
RT-1778KSDF **94**
RT-1778ORF3 **109**
RT-1778ORF4 **109**
RT-1778ORF5 **109**
RT-1778PR2DC **135**

RT-1778PR3D **106**
RT-1778PR5D **106**
RT-1779 **101**
RT-1779KS **101**
RT-1779KSD **93**
RT-1779KSL **101**
RT-1779L **101**
RT-1779S **101**
RT-1779SD **93**
RT-1779SDL **93**
RT-1779SL **101**
RT-1782BOS-DXS **206**
RT-1782KORF3 **109**
RT-1782KORF5 **109**
RT-1782KPR3D **106**
RT-1782KPR5D **106**
RT-1782KSD **94**
RT-1782KYSDF **94**
RT-1782ORF3 **109**
RT-1782ORF4 **109**
RT-1782ORF5 **109**
RT-1782PR3D **106**
RT-1782PR5D **106**
RT-1782SD **94**
RT-1783P3 **135,151**
RT-1821KP **149**
RT-1821P **149**
RT-1822P18A **151**
RT-1823P12A **151**
RT-1848 **151**
RT-1876KFORF3 **109**
RT-1876KFORF5 **109**
RT-1876KSDGLF **93**
RT-1876KYS DGLF **93**
RT-1878BOS-D2L **207**
RT-1878BOS-D2LS **207**
RT-1878BOS-D2LVS **206**
RT-1878BOS-E2L **207**
RT-1878BOS-E2LS **207**
RT-1878KBOS-D2L **207**
RT-1878KBOS-D2LS **207**
RT-1878KBOS-D2LSF **206**
RT-1878KBOS-D2LVS **206**
RT-1878KBOS-E2L **207**
RT-1878KBOS-E2LF **206**
RT-1878KBOS-E2LS **207**
RT-1878KSDF **94**
RT-1882BOS-D **207**
RT-1882BOS-DS **207**
RT-1882BOS-DVS **206**
RT-1882BOS-E **207**
RT-1882BOS-ES **207**

Part Number Index

RT-1882KBOS-D **207**
RT-1882KBOS-DS **207**
RT-1882KBOS-DVS **206**
RT-1882KBOS-DXS **206**
RT-1882KBOS-E **207**
RT-1882KBOS-ES **207**
RT-1882KP **149**
RT-1882ORF3 **109**
RT-1882ORFPLV4 **151**
RT-1882P **149**
RT-1882P18A **151**
RT-1883P12A **151**
RT-1889 **101**
RT-1889KS **101**
RT-1889KSD **93**
RT-1889KSDL **93**
RT-1889KSD-S3 **93**
RT-1889KSL **101**
RT-1889KS-S3 **102**
RT-1889KYFORF3 **109**
RT-1889KYFORF5 **109**
RT-1889KYS **101**
RT-1889KYS D **93**
RT-1889KYSGLF **102**
RT-1889L **101**
RT-1889S **101**
RT-1889SD **93**
RT-1889SDL **93**
RT-1889SD-S3 **93**
RT-1889SL **101**
RT-1889S-S3 **102**
RT-1889YS **101**
RT-1889YSD **93**
RT-1889YS DR **93**
RT-1889YSR **101**
RT-1892KSD **94**
RT-1892KYS D **94**
RT-1892KYSDF **94**
RT-1892SD **94**
RT-1892YS DR **94**
RT-1910-4 **219**
RT-1913-2 **219**
RT-1913-3 **219**
RT-1913-4 **219**
RT-1922 **219**
RT-1931-4 **219**
RT-1969 **99**
RT-1989S **101**
RT-2075-110 **122**
RT-2075-220 **122**
RT-2075-PB **219**

RT-2111C **122,226**
RT-2111C-WLS **122,226**
RT-4415RP-50 **158**
RT-4420-DCBL **189**
RT-4420-DCVT **189**
RT-4420-DCWT **189**
RT-4420-SPBK **189**
RT-4420-SPBL **189**
RT-4420-SPGN **189**
RT-4420-SPRD **189**
RT-4422-38RM **188**
RT-4426-DBK **184**
RT-4426-OBKN **184**
RT-4426-OUVN **184**
RT-4426-UVTL-02 **184**
RT-4454-14 **135**
RT-4464-02 **156**
RT-4474-6 **171**
RT-4474-8 **171**
RT-4484-16/4X6 **99**
RT-4485 **205**
RT-4487G-083 **221**
RT-4488-01 **25**
RT-4488-02 **25**
RT-4488-03 **25**
RT-4488-04 **25**
RT-4489STRAP **152**
RT-4490BOS1 **205**
RT-4491-Q1 **117**
RT-4491-Q2 **117**
RT-4491-Q3-2G **117**
RT-4491-Q4-2G **117**
RT-4492U **205,215**
RT-4494 **136**
RT4494-P **136**
RT-4517-0002M **60,164,166**
RT-4517-0003M **60,164,167**
RT-4517-4079VF15M **63,164**
RT-4517-5070F15M **164,165**
RT-4517-7070F20M **164,165**
RT-4517-10070F30M **164**
RT-4517-10070F35M **164,165**
RT-4517-10070F40M **164**
RT-4517-12075F35M **164,166**
RT-4517-80150F65M **164,166**
RT-4517-100100F30M **164**
RT-4517-100100F40M **164,165**
RT-4517-100100TRAPP35M **164,166**
RT-4517-100220F120M **164,167**

RT-4517-230120T80F90M **164,167**
RT-4517-IND01 **169**
RT-4517-PB3 **164,166**
RT-4517-PB3M **164,166**
RT-4517-PB4 **164,166**
RT-4517-PB4M **164,166**
RT-4517-T6565F7 **164,165**
RT-4517-T6565F7M **164,165**
RT-4517-T7993F20 **164,165**
RT-4517-T7993F20M **164,165**
RT-4525HGA **89,205,215**
RT-4525TILT **99**
RT-4525TILT-A **99**
RT-4525TILT-B **99**
RT-4527EXA **121**
RT-4527EXAG **121**
RT-4527LMI3 **121**
RT-4527LTOMO **121**
RT-4527QFIX **121**
RT-4529M **121**
RT-4535BOS **205**
RT-4535BOSMRI **205**
RT-4535KV **17,205**
RT-4535KV01 **17,205**
RT-4535KV03 **17,205**
RT-4536KV-01 **203**
RT-4536KV-100 **203**
RT-4536-NS40 **204**
RT-4536-NS50 **204**
RT-4536-NS60 **204**
RT-4536-NS65 **204**
RT-4536-SA01 **204**
RT-4543S **136**
RT-4543WALL **224**
RT-4544-01 **141**
RT-4544KV-10 **18,139**
RT-4544KV-13 **18,139**
RT-4544KV-IND **166,169**
RT-4546 **133**
RT-4546-01 **133**
RT-4546-02 **133**
RT-4546-03 **135**
RT-4546-04 **135**
RT-4546-05 **135**
RT-4546AA-01 **134**
RT-4546AW-01 **134**
RT-4546C **61,134**
RT-4546L **136**
RT-4546MRI **133**
RT-4548 **99**
RT-4550CN01 **20**
RT-4550FE **20**
RT-4550GEC **20**
RT-4550GEH **20**
RT-4550GEL **20**
RT-4550GEP **20**
RT-4550GER **20**
RT-4550GER2 **20**
RT-4550KVGEC **19**
RT-4550KVGEL **19**
RT-4550KVGER **19**
RT-4550KVPBR **19**
RT-4550KVPBRPM **19**
RT-4550KVPH01 **19**
RT-4550KVQ **14**
RT-4550KVSS3 **19**
RT-4550KVSS4 **19**
RT-4550KVSS5 **19**
RT-4550KVVSSPM **19**
RT-4550KVTAQ **19**
RT-4550KVTAQ2 **19**
RT-4550PBR **20**
RT-4550SEA **20**
RT-4550SS3 **20**
RT-4550SS4 **20**
RT-4550TAQ **20**
RT-4550TAQ2 **20**
RT-4551BAR **24**
RT-4551BAR-01 **24**
RT-4551BAR-03 **24**
RT-4551BAR-04 **24**
RT-4551BAR-05 **24,204**
RT-4551BARMRI **24,62**
RT-4551CART **226**
RT-4551KV **15**
RT-4551KV0 **15**
RT-4551KV-01 **15**
RT-4551KV2 **16**
RT-4551KV-03 **202**
RT-4551KV5F **16**
RT-4551KV8 **16**
RT-4551KVI3 **16**
RT-4551KVI8 **16,64**
RT-4551KVI9 **16,64**
RT-4551KVA-ELK **15**
RT-4551KVVBHRD **15**
RT-4551SRV **14**
RT-4552 **89**
RT-4552A **120**
RT-4552CART **226**
RT-4552KV **17,87**
RT-4552KV-01 **215**

Part Number Index

RT-4552MRI	89	RT-7001	219
RT-4552P	120	RT-7003	219
RT-4558-B1	64	RT-A001	116
RT-4558-B2	64	RT-A782KSD	92
RT-4558CB03	59	RT-A876KSDGLF	92
RT-4558KV4	63,64	RT-A889KYSD	92
RT-4558KV4-01	63,64	RT-A892KYSD	92
RT-4588-01	64	RT-A892KYSDF	92
RT-4600-01	71	RT-B889KYCF2	72,77
RT-4600-01-MRI	71,195	RT-B889KYCF2A	72,77
RT-4600-02	71	RT-C829K	204
RT-4600-03	76	RT-C876K	204
RT-4600-03-MRI	76	RT-C878K	204
RT-4600-10	72,77	RT-C889K	204
RT-4600-12	72,77	RT-PUMP220Q1	170
RT-4600-14	72,77	RT-PUMPQ1	170
RT-4600-20	72,77	RT-PUMPQ-TS	170
RT-4600KV-01	17,71	T-1882BOS-E	207
RT-4635KV-01	17	THRMTX100	148
RT-4635KV-100	17	THRMTX101	148
RT-4700-10	192	THRMTX102	148
RT-4700-20	192	TRT100	45
RT-4800-01	150	VL04C	161,162
RT-4800-02	61	VL14C25	161
RT-4800-04	62,204	VL0017	60,161,162
RT-4800-100	42	VL0018	161,162
RT-4800-B1	63	VL0021	161
RT-4800-B2	63	VL0022	60,161,162
RT-4800-B3	58	VL37	161,163
RT-4800-FS	60,152	VL71FC	161,163
RT-4800-GL	150	VLA80C	160
RT-4800-H30	150	VLARM01	161,162
RT-4800-H45	150	VLARM01C	161,162
RT-4800-KS	60,152	VLARM01FC	161,162
RT-4800-SR	152	VLARM02C	161,162
RT-5100-04	214	VLARM02FC	161,162
RT-5100-51CE	39	VLB40	160
RT-5100-51CU	39	VLB40C	160
RT-5100-51ST	39	VLE225	160
RT-5100-52	39	VLE225C	160
RT-5100-53	39	VLF15	160
RT-5100-54	39	VLF15C	160
RT-5100-100	33	VLF15FC	160
RT-5100-100S	33	VLFBB01	160
RT-5100-400	33,214	VLFBB01C	160
RT-5100-400S	33,214	VLFBB01FC	160
RT-5100-500	31,38	VLFBB02FC	160
RT-5100-500S	31,38	VLG26C	160
RT-5100-700	32	VLG26FC	160
RT-5100-700S	32	VLG35	160
RT-5200-01	195	VLG35C	160
RT-5300	36	VLG35FC	160

VLG40	160
VLG40C	160
VLG40FC	160
VLH90C	160
VLJ20	160
VLJ20C	160
VLJ20FC	160
VLPLV01	160,163
VLPLV01C	160,163
VLPLV01FC	160,163
VLPLV02	160,163
VLPLV02C	160,163
VLPLV02FC	160,163
VLPLV09C	160,163
VLPLV09FC	160,163
VLPLV10C	160,163
VLPLV10FC	160,163
VLSBRT202FC	58
VLTYSO1CX	161,163
VLTYSO2CX	161,163
VLWGB03	161,162
VLWGB03C	161,162
VLWGB04C	131,161,162
VLWGB05C	131,161,162

© 2024 CQ Medical. All rights reserved.

CQ Medical is a trademark of Medtec LLC. BoS, Fibreplast, Qfix, Positioning Patients for Life, Symphony are registered trademarks of Qfix Systems LLC.

Evolve, HipFix, Interloc, Medtec, Posicast, Posifix, ProtonSeries, and Uni-frame are registered trademarks of Medtec LLC.

Access, Access 360, Adapt-It, AirDrive, AirDrive Caddie, AirDrive Trolley, AirShuttle, Alta, ArmShuttle, Assure, Aqua-Brief, Aquaplast RT, BoS, Cantilever Board, Cosmas Cup, DoseMax, Encompass, FlexLock, IntegraBite, Integrated Shim, InfinityEdge, InfinityLock, InkAlign, INSIGHT, kVue, Low-e, Low-Pro, OneTouch, Portrait, ProBoard, Prone CSA Kit, Pronumbra, RapidHeat, Shoulder-Loc, SofTouch, Stealth Beam, Tilt-Pro, Tilt-Pro Base, Variable Perf, Virtual Indexing, VacQfix, ZiFix, ZiFix Traverse are trademarks of Qfix Systems LLC.

Accuform, Align, Bi-Axial Arm Support System, Body Pro-Lok, Body Pro-Lok ONE, Clam-Lok, ClearVision, Combifix, ComfortCare, C-Qual, C-Qual M, Cybermark, DoseMatch, Feetfix, Fixator, FlexiCoil, FlexiMarc, FreedomView, FusionCoil, GlideTrack, Helping Hands, IMRT Reinforced Thermoplastic, Iso-Align, Kneefix, Lok-Bar, Monarch, MRSeries, MultiFix, New Horizon, ONEBridge, ONEPlatform, PointCoil, PolyMark, Posiboard, Posirest, Positilt, Precise Bite, Prodigy, ProForm, Pronelok, Pron-pillo, PureVision, RediFoam, Solstice, Solstat, ThermFix, Thorawedge, TotalIRT, trUpoint ARCH, Type-S, Universal Couchtop, Vac-Lok, Wing Board and ZENTEC are trademarks of Medtec LLC.

Varian, TrueBeam, Exact, Acuity, Ximatron, Calypso, HyperArc and Halcyon are trademarks of Varian Medical Systems. Lightspeed, HiSpeed, ProSpeed and Discovery are trademarks of GE Healthcare. Brilliance, AcQSim, Gemini Picker PQ 5000 are trademarks of Philips Medical Systems. SOMATOM, ZXT and TXT are trademarks of Siemens AG. MAGNETOM Aera, Skyra and Vida are trademarks of Siemens. Precise and Medical Intelligence I-Beam are trademarks of Elekta AB. Kevlar and Tyvek are trademarks of E.I. DuPont de Nemours and Company. Sharpie is a trademark of Sanford L.P. DecoColor is a trademark of Uchida of America, Corp. Pro-Tekt is a trademark of MEDRAD, INC. U.S.A. Formica is a trademark of the Formica Corporation. Suremark, Clearline, PortalMark, Visionmark, Powermark, Liquimark, and BeautyLine are registered trademarks of The Suremark Company. ShadowForm is a trademark of IZI Medical Products. Staph-Chek is a registered trademark of Morrison Medical. Bolx I and Bolx II are registered trademarks of Action Products. RectalPro is a trademark of QLRAD. SpringLoc is a trademark of SchureMed. FCT Embrace is a registered trademark of Fujifilm Medical Systems USA, Inc. GrayDuck Stents and GrayDuck Dart are trademarks of POLL Medical. Grip Rings is a trademark of VanArsdale Innovative Products, Inc. Spee-D-Mark is a trademark of PDC. BioXmark is a registered trademark of Nanovi A/S. Accusyte is a trademark of Radiation Products LLC. BrachyGel is a trademark of Brachyfoam, Inc.

In accordance with Section 287(a) of Title 35 of the United States Code, the reader is hereby placed on notice of Qfix Systems LLC's, Medtec LLC's, and CQ Medical's rights in the United States Patents listed on CQ Medical's site (www.CQmedical.com/patents) and associated with the the following products or their accessories or components.

This catalog contains information about products which may or may not be available in particular countries. Each country has specific laws and regulations governing the commercialization of medical devices and the communication of information regarding medical devices in printed and digital media. Products appearing in this catalog or on our website may or may not have received approval, clearance, or marketing authorization by a governmental regulatory body in any particular country, or may have received approval, clearance, or marketing authorization for different indications and restrictions in different countries, or may be for investigational use only. A product's appearance in this catalog should not be construed as a solicitation or promotion for said product, nor any indication which is not authorized by the laws and regulations of the country where the reader resides. All products may not be licensed in accordance with Canadian law.

visionrt | COMPATIBLE

VISIONRT COMPATIBILITY

The following products have been identified as VisionRT Compatible: ClearVision & ClearVision 2 Head Only and Head, Neck & Shoulders, Solstice SRS & Solstat Immobilization Systems with ClearVision mask and Precise Bite, Encompass SRS Immobilization System with Assure Open View Fibreplast Head Only mask, Aquaplast RT Custom Bolus, Assure Open View Head, Neck & Shoulder mask.

- Vision RT is unable to comment on, nor make claims, about the immobilization rigidity, Dosimetric properties, clinical effectiveness, or patient alignment reproducibility when using these products.
- Compatibility is subject to users following vendor guidelines when using these products in conjunction with Surface Guided Radiotherapy systems, and subject to users following Vision RT's guidelines for drawing Regions of Interest for use in treatment.
- The vendor of the products is responsible for ensuring that users are in receipt of guidelines for using these products in conjunction with Surface Guided Radiotherapy systems. Vendors may change their guidelines from time to time without reviewing changes with Vision RT. Vision RT is not liable for misuse of the products.
- Vision RT makes no comment on, and is not liable for, suitability or otherwise of use of these products for the respective procedure(s) for which they are advertised or any other procedure.
- Purchasers are responsible for making their own choices as to the products selected by them.



 **CQ MEDICAL™**
Care Smarter

info@CQmedical.com | CQmedical.com

